

# DESIGNER'S GUIDE

3V Lithium Batteries

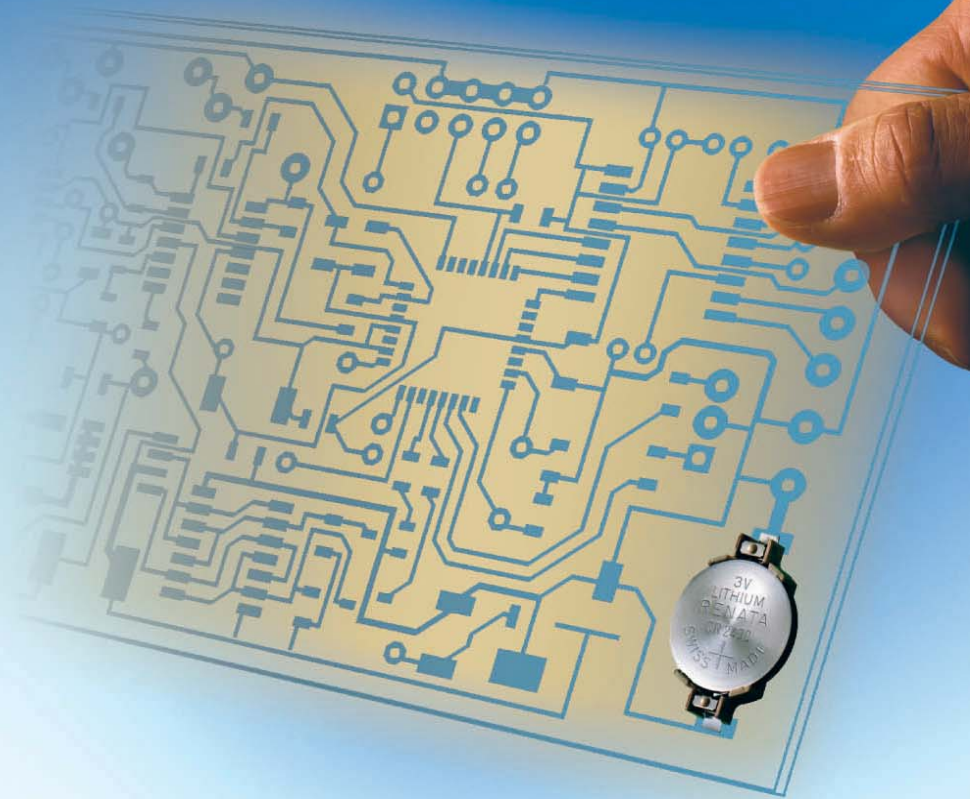

 SWATCH GROUP ELECTRONIC SYSTEMS

the **swiss** power source

**renata**   
batteries



# Keynote of the CEO



Dear Customers, dear Readers,

Reliability is the keyword for our lithium batteries, their related products, and our services. Renata SA is the foremost European button cell producer in these fields and has enjoyed more than 30 years of manufacturing experience for such primary batteries. I am pleased to see that an increasing number of global customers are convinced by the excellent quality in performance and durability of our Renata products.

In addition to offering you a great variety of standard lithium batteries, power modules, and holders, we also focus on delivering you customized solutions and services according to your specifications. As a team with a long record of success we're delighted to help you design the best power solutions for your applications.

Speed is always important in today's fast changing environments. It's our goal to help you keep your time schedule and to work with you to deliver your customized products in the shortest time periods. Therefore a team of experienced engineers, global sales people, and well selected professional distribution partners in more than 100 countries are at your disposal.

With this in mind and our spirit of Never Stop Improving we would like to create outstanding values for you: our respected customers.

Wishing you success in everything you do,

A handwritten signature in black ink, appearing to be "M. Bieri". The signature is stylized and fluid.

Marcel Bieri  
CEO Renata SA

# RENATA – The Swiss Power Source

## Our success story



RENATA SA, with its head office in Itingen near Basel (Switzerland), is a worldwide leading producer of button cells for electronic applications. The business – **founded in 1952** with the goal to produce mechanical parts for wristwatches – specialised in button cells in the late 70s.

Today, in the modern production plant at Itingen, all services (research and development, production, quality assurance and marketing) are grouped.

The production plant at Itingen is highly automated and produces over **one million batteries a day**. This includes silver oxide batteries for wrist watches, zinc air batteries for hearing aids and lithium 3V button cells for industrial applications (automotive, medical, telecommunications etc.). In the same way a complete assortment of holders for lithium-batteries are produced.

RENATA manages the whole production process: from punched battery housings, over the injection molded synthetic seal and the sourcing of the battery components up to the final assembly. Through this **high production depth** RENATA earned itself a reputation as an extremely flexible and reliable supplier of batteries.

The consistent high quality and power of the button cells is not lastly a result of the reliable quality assurance system of RENATA. This includes the complete production process – from the inspection of incoming raw materials right through to the testing of the finished product. RENATA is **ISO 9001:2000** certified and a subsidiary of **The Swatch Group Ltd.** in Biel, Switzerland.

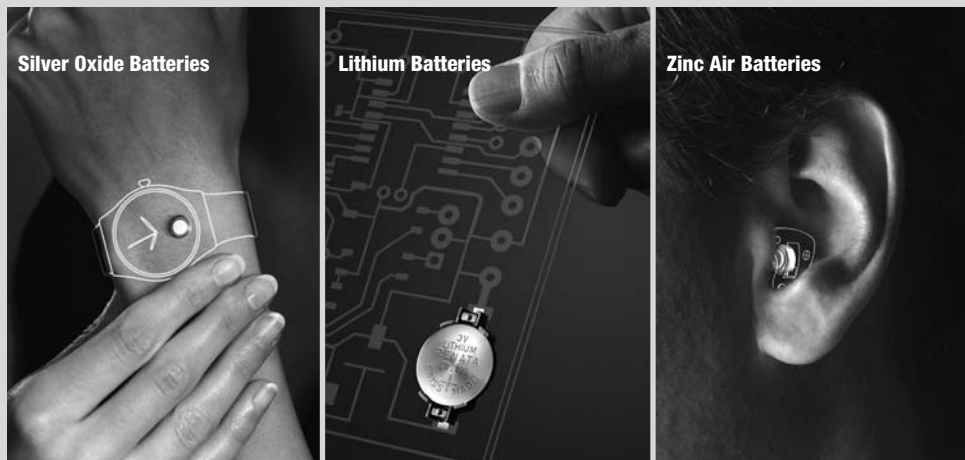

# Table of Contents

## Introduction

### Keynote of the CEO

### RENATA SA – The Swiss Power Source

## Product Catalogue

### Coin Cells

Introduction	5
Standard naked coin cells	6
High Temperature Coin Cells	17
Packaging Options	19

### Coin Cells with Tabs

Two pins horizontal mounting	20
Three pins horizontal mounting	21
Two pins vertical mounting	22
Three pins vertical mounting	23
Isotan tabs	24
Packaging Options	25

### Battery Holders

Surface Mounting Technology (SMT)	26
Through-hole mounting	27
Through-hole mounting with positioning pins	29
Packaging options	30

### Encapsulated Batteries (Power Modules)

Overview	32
For soldering	33
For plug-in	36
Packaging options	38

### Customized Battery Solutions

Optional antimagnetic case material	39
Optional tab configuration	39

## Technical Information

Chemistry and Construction	40
----------------------------	----

Electrical & Temp. Performance	41
--------------------------------	----

## Frequently Asked Questions (FAQ)

General electrical performance	43
Influence of temperature on electrical performance	46
Influence of storage / ageing on electrical performance	47
Influence of Contact Material	47
General FAQs	47

Passivation Phenomena	48
-----------------------	----

Soldering	49
-----------	----

## Technical Consultancy Service

Application design support	50
----------------------------	----

Application Worksheet	51
-----------------------	----

## Safety Guidelines

Handling instructions	53
Underwriters Laboratories' (UL) Safety Approval	54
UL safety tests	56
Disposal of used batteries	59

## Quality Control

Quality Management System	60
---------------------------	----

Process Flow Chart	61
--------------------	----

## Certificates and Declarations

Certificate: ISO 9001:2000	62
Certificate: UL Safety Approval	63
Declaration: Conformity with RoHS	63
Declaration: Conformity with Battery Directive 1991/157/EC	64
Declaration: Mercury-free products	65
Declaration: Conformity with IATA, ICAO and DOT regulations	66



# Coin Cells

## Introduction

Since 1982, when RENATA launched the industrial production of lithium batteries, the range of applications has grown continuously. In addition to the wide spectrum of memory backup power sources, RENATA lithium batteries are used for different applications in the computer and automotive industries, telecommunications, medical industry and in an increasing number of portable devices (measuring equipment, payment systems, toys etc.).

RENATA lithium batteries meet the highest quality standards and offer excellent reliability.

### **Advantages**

- Nominal voltage of 3V, approx. twice the voltage level of alkaline button cells
- Wide operating temperature range depending on battery model
- Low self discharge of less than 1% per year at 23°C
- Best practical capacity/volume ratio
- Superior leakage resistance
- Excellent storage characteristics, up to 10 years storage with minimum deterioration
- Safe products: all Renata coin cells are UL-recognized products (File No. MH14002)
- Environmental-friendly, do not contain toxic substances
- No air transport restrictions (non hazardous)
- Available in a wide range of solder contact configurations or in combination with our battery holders

# Coin Cells

## Standard naked coin cells

### General characteristics

- Self-discharge: less than 1% per year at 23°C
- Shelf life: up to 10 years at max. 23°C
- Stable voltage during shelf life
- High reliability of operation, including leakage resistance
- Contains no heavy metals

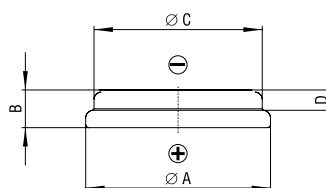

### Dimensions and weights

Model	Max. Dimensions (mm)				Weight (g)	Part.No.*
	A	B	C	D		
CR1025	10.00	2.50	Ref. 6.0	min 0.08	0.60	700263
CR1216	12.50	1.60	Ref. 9.0	min 0.02	0.70	700268
CR1220	12.50	2.00	Ref. 9.0	min 0.06	0.80	700273
CR1225	12.50	2.50	Ref. 9.0	min 0.08	0.90	700281
CR1616	16.00	1.60	Ref. 12.0	min 0.02	1.10	700287
CR1620	16.00	2.00	Ref. 12.0	min 0.06	1.20	700291
CR1632	16.00	3.20	Ref. 12.0	min 0.08	1.80	700296
CR2016 MFR	20.00	1.60	Ref. 18.0	min 0.05	1.70	100270
CR2016	20.00	1.60	Ref. 16.0	min 0.02	1.70	700303
CR2025 MFR	20.00	2.50	Ref. 17.0	min 0.05	2.50	100271
CR2025	20.00	2.50	Ref. 16.0	min 0.08	2.30	700309
CR2032 MFR	20.00	3.20	Ref. 17.0	min 0.05	2.80	100272
CR2032	20.00	3.20	Ref. 16.0	min 0.08	2.80	700322
CR2320	23.00	2.00	Ref. 18.0	min 0.06	2.70	700344
CR2325	23.00	2.50	Ref. 19.0	min 0.08	3.00	700348
CR2430	24.50	3.00	Ref. 20.0	min 0.08	4.10	700359
CR2450N	24.50	5.00	Ref. 22.3	min 2.50	5.90	700377
CR2477N	24.50	7.70	Ref. 22.4	min 5.30	8.30	700391

\*Packaging: Industrial Bulk (IB-Trays)





### Electrical characteristics

Model	Nominal capacity (mAh)	Standard discharge current (mA) <sup>1)</sup>	Max. continuous discharge current (mA) <sup>2)</sup>	Operating Temperature (C) <sup>3)</sup>
CR1025	30	0.05	0.40	-40/+85°
CR1216	25	0.05	1.00	-40/+85°
CR1220	38	0.05	1.00	-40/+85°
CR1225	48	0.10	1.00	-40/+85°
CR1616	50	0.10	1.00	-40/+85°
CR1620	68	0.10	1.00	-40/+85°
CR1632	125	0.20	1.50	-40/+85°
CR2016 MFR	90	0.20	3.00	-30/+60°
CR2016	80	0.20	3.50	-40/+85°
CR2025 MFR	165	0.30	3.00	-30/+60°
CR2025	170	0.30	3.00	-40/+85°
CR2032 MFR	225	0.40	3.00	-30/+60°
CR2032	235	0.40	3.00	-40/+85°
CR2320	150	0.20	3.00	-40/+85°
CR2325	190	0.30	3.00	-40/+85°
CR2430	285	0.50	4.00	-40/+85°
CR2450N	540	0.80	3.00	-40/+85°
CR2477N	950	1.00	2.50	-40/+85°

1) Standard discharge current: 100% of nominal capacity is obtained by discharging the cells at this current rates.

2) The maximum current is determined for a yield of 70% of the nominal capacity with a cut-off voltage of 2.0V, at 23°C. For currents exceeding those given above or pulsed current, please contact Renata.

3) In applications where the battery is exposed to temperatures above 70°C, please contact Renata for consultancy.

# Coin Cells

Standard naked coin cells

**CR1025**  Rated capacity: 30 mAh  
Average weight: 0.6 g

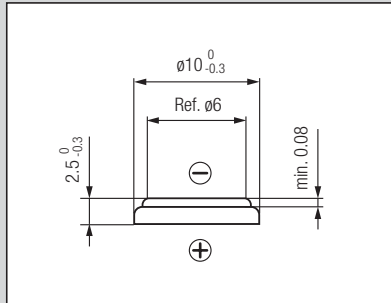

Discharge performance at 23°C

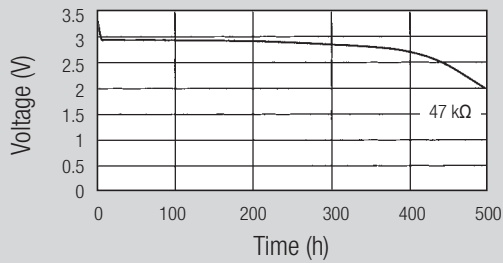

Discharge performance at 23°C

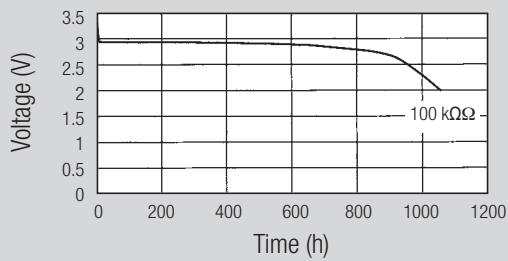

Temperature performance

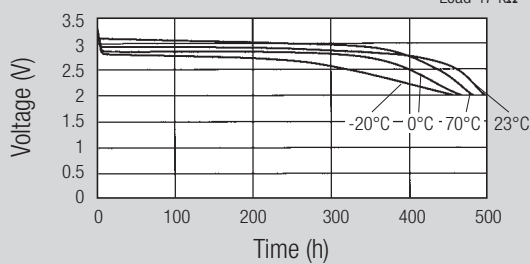

Cell capacity at various loads

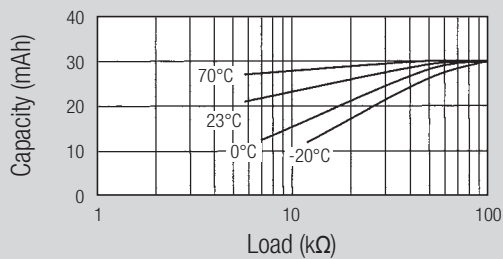

**CR1216**  Rated capacity: 25 mAh  
Average weight: 0.7 g

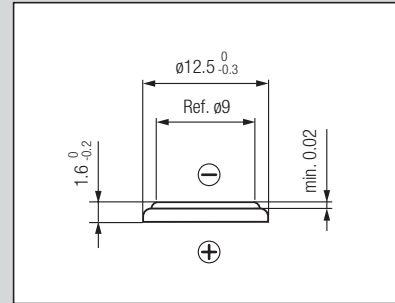

Discharge performance at 23°C

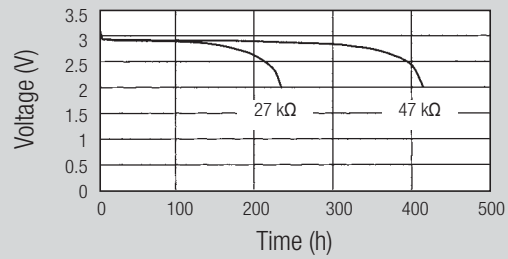

Discharge performance at 23°C

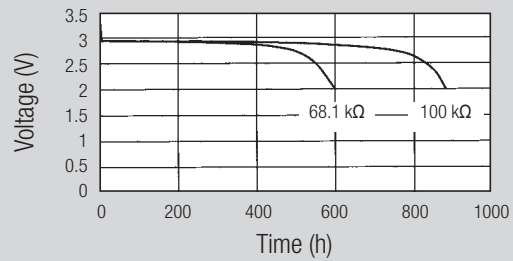

Temperature performance

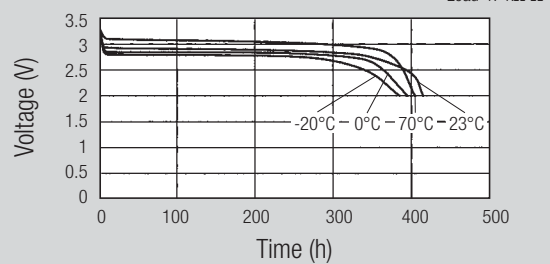

Cell capacity at various loads

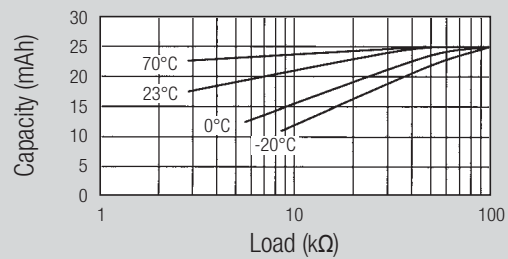



**CR1220**  Rated capacity: 38 mAh  
Average weight: 0.8 g

**CR1225**  Rated capacity: 48 mAh  
Average weight: 0.9 g

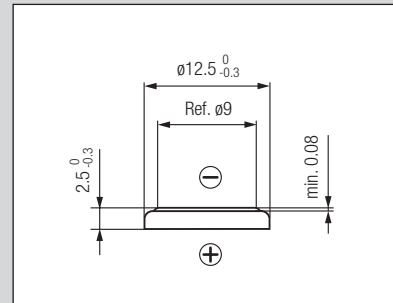
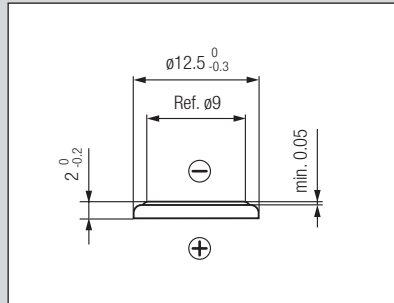

Discharge performance at 23°C

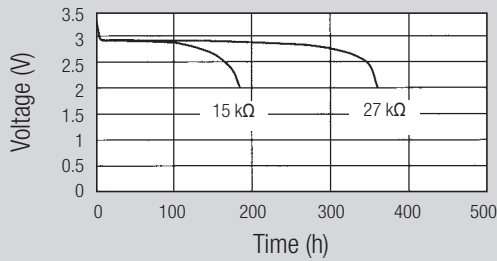

Discharge performance at 23°C

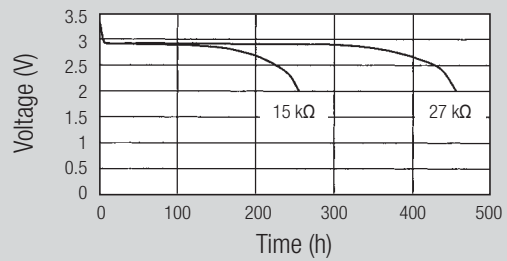

Discharge performance at 23°C

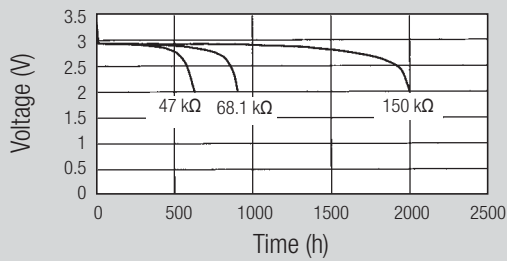

Discharge performance at 23°C

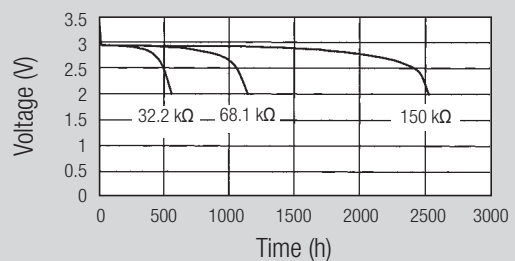

Temperature performance

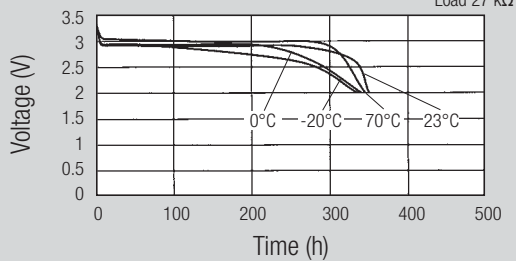

Temperature performance

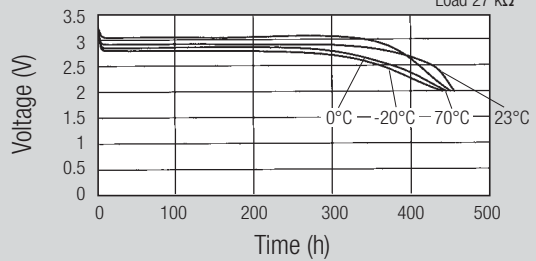

Cell capacity at various loads

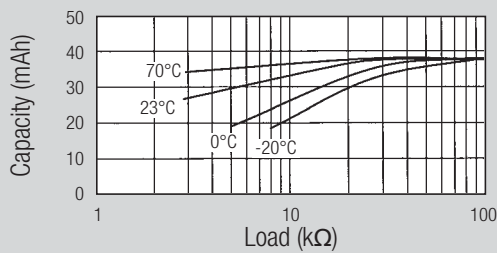

Cell capacity at various loads

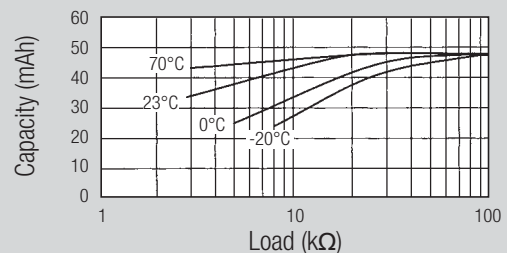

# Coin Cells

Standard naked coin cells

**CR1616**  Rated capacity: 50 mAh  
Average weight: 1.1 g

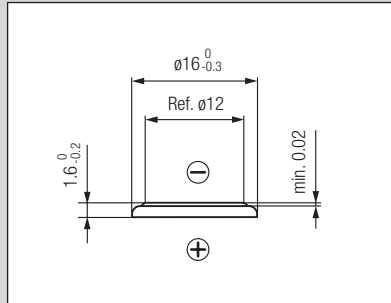

Discharge performance at 23°C

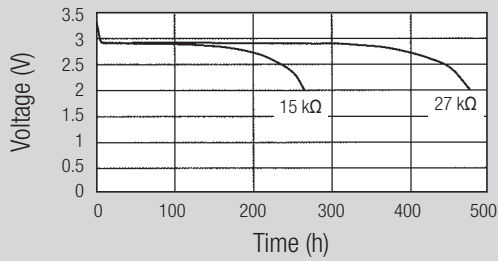

Discharge performance at 23°C

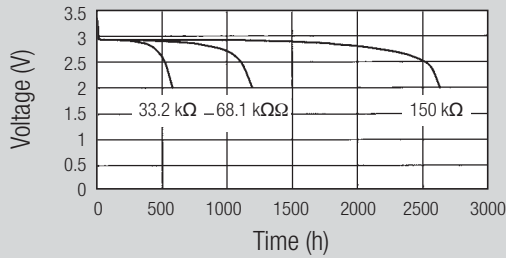

Temperature performance

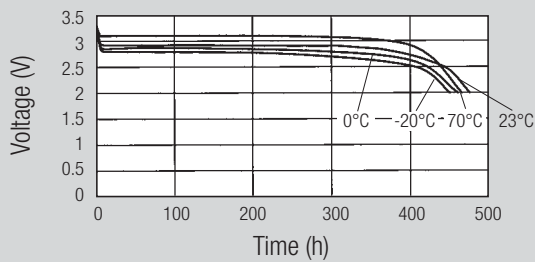

Cell capacity at various loads

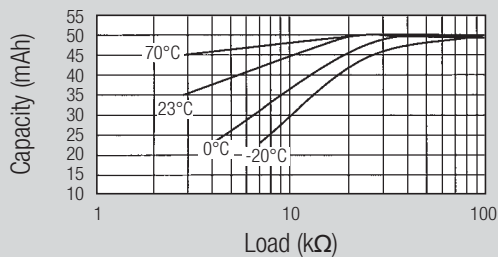

**CR1620**  Rated capacity: 68 mAh  
Average weight: 1.2 g

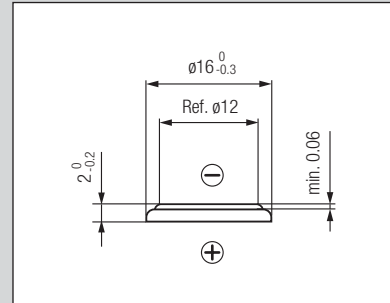

Discharge performance at 23°C

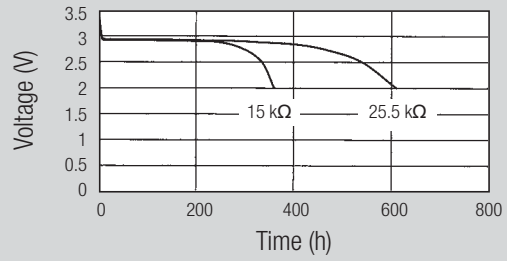

Discharge performance at 23°C

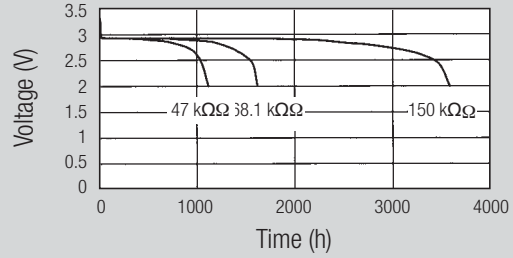

Temperature performance

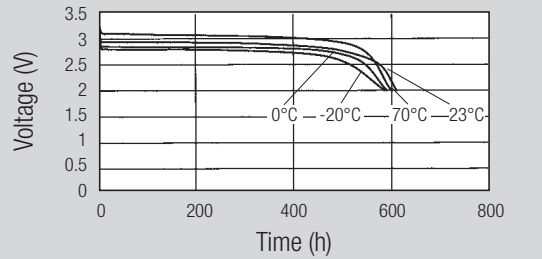

Cell capacity at various loads

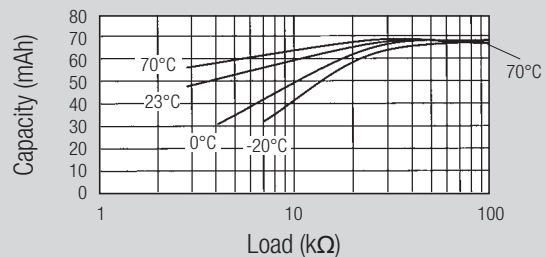



**CR1632**  Rated capacity: 125 mAh  
Average weight: 1.8 g

**CR2016 MFR**  Rated capacity: 90 mAh  
Average weight: 1.7 g

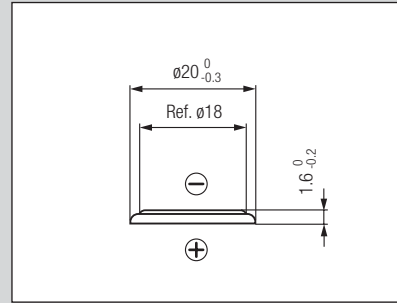
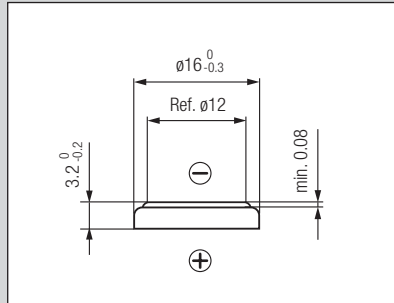

Discharge performance at 23°C

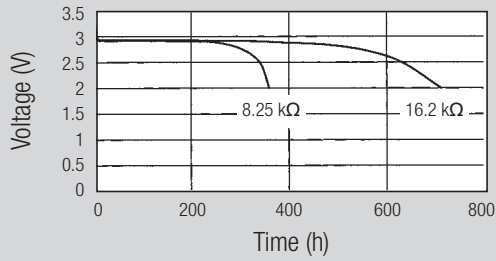

Discharge performance at 23°C

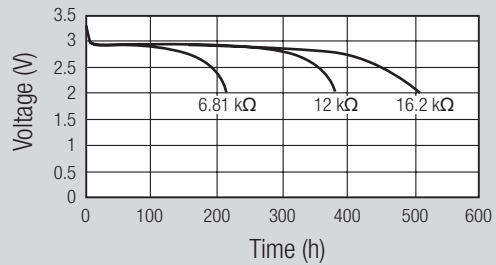

Discharge performance at 23°C

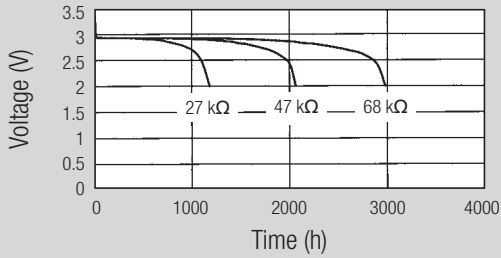

Discharge performance at 23°C

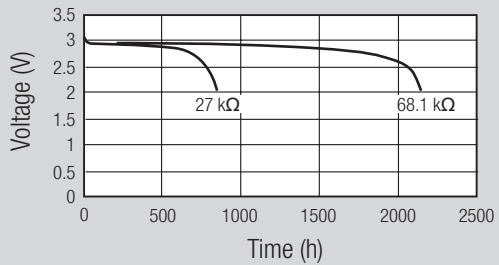

Temperature performance

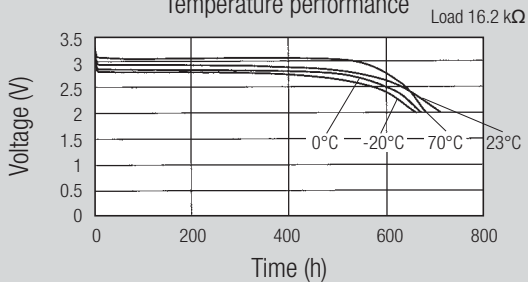

Temperature performance

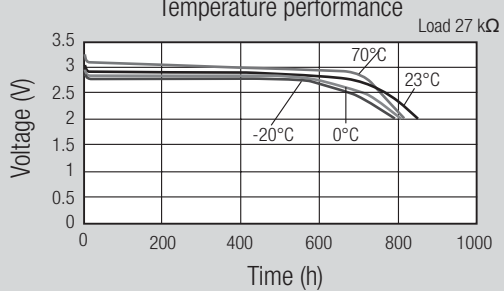

Cell capacity at various loads

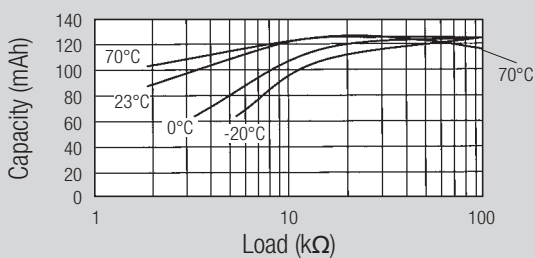

Cell capacity at various loads

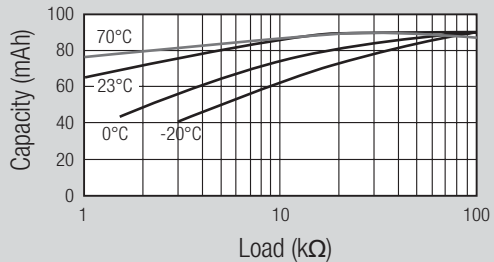

# Coin Cells

Standard naked coin cells

**CR2016**  Rated capacity: 80 mAh  
Average weight: 1.7 g

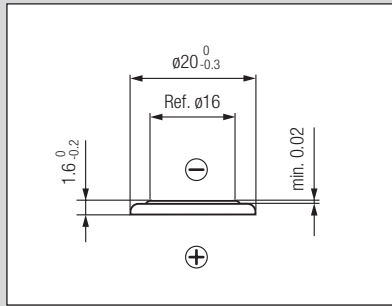

Discharge performance at 23°C

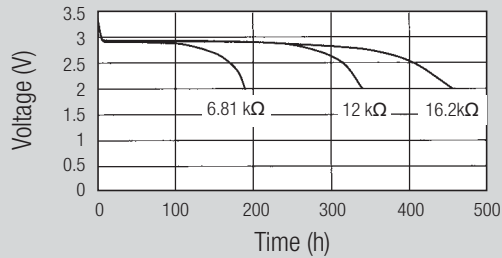

Discharge performance at 23°C

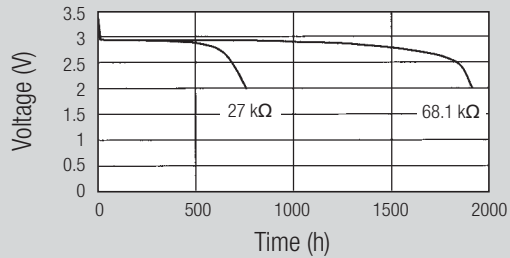

Temperature performance

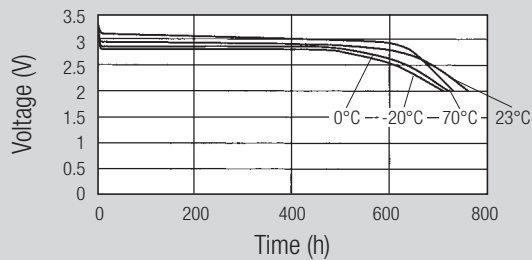

Cell capacity at various loads

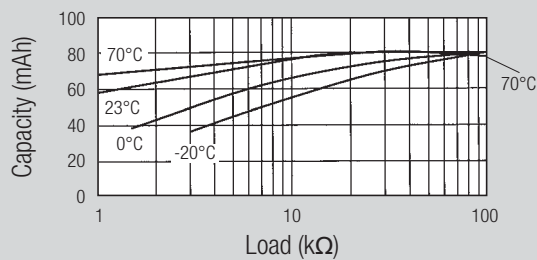

**CR2025 MFR**  Rated capacity: 165 mAh  
Average weight: 2.5 g

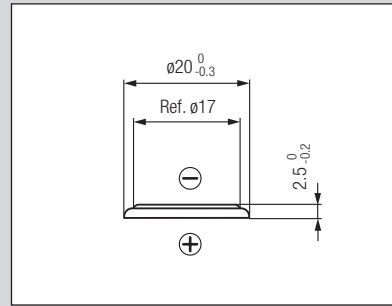

Discharge performance at 23°C

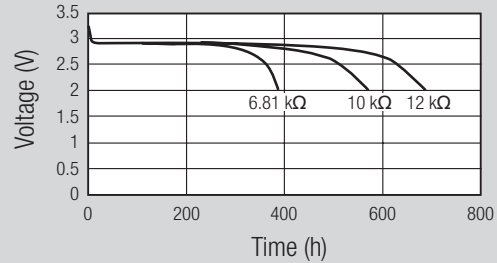

Discharge performance at 23°C

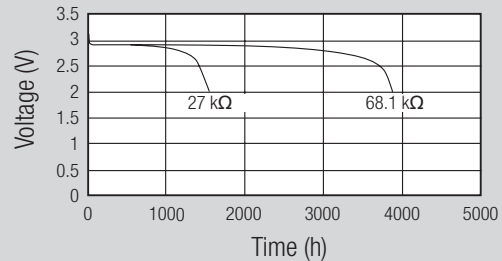

Temperature performance

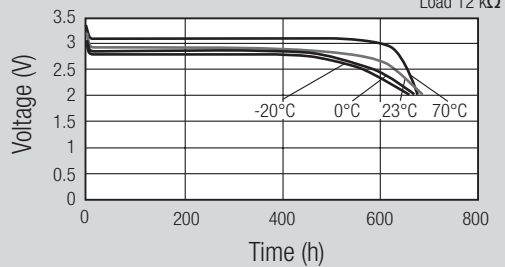

Cell capacity at various loads

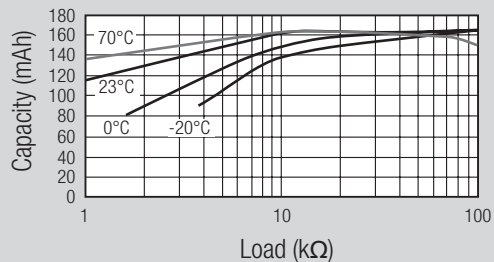



**CR2025**  Rated capacity: 170 mAh  
Average weight: 2.3 g

**CR2032 MFR**  Rated capacity: 225 mAh  
Average weight: 2.8 g

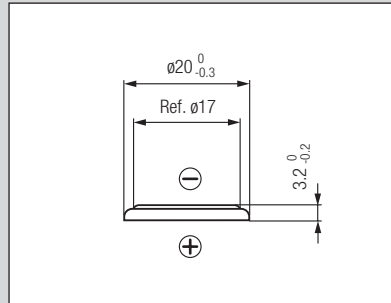
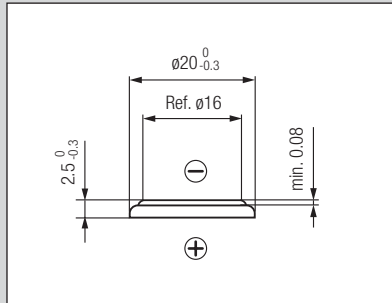

Discharge performance at 23°C

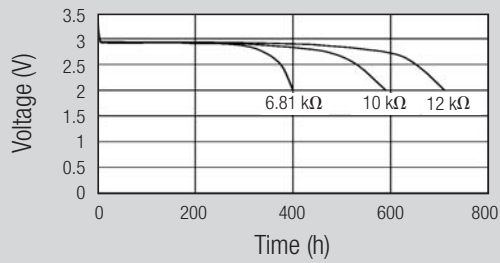

Discharge performance at 23°C

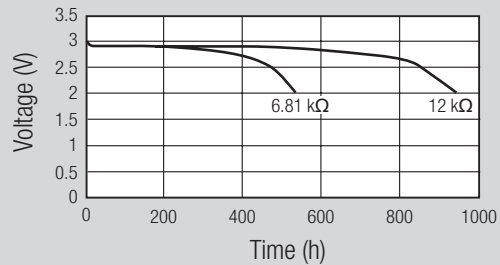

Discharge performance at 23°C

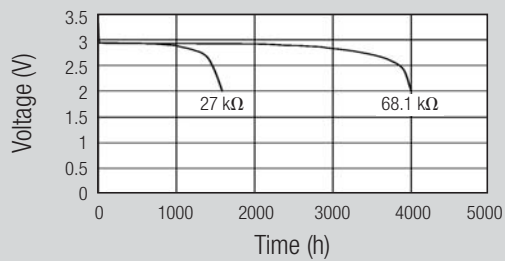

Discharge performance at 23°C

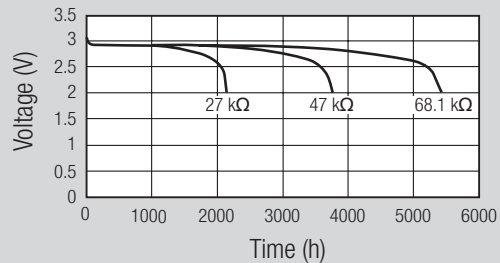

Temperature performance Load 12 kΩ

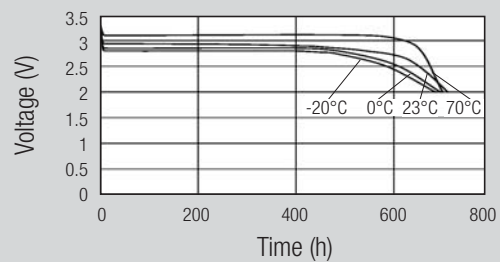

Temperature performance Load 12 kΩ

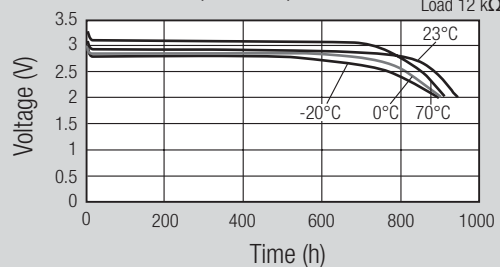

Cell capacity at various loads

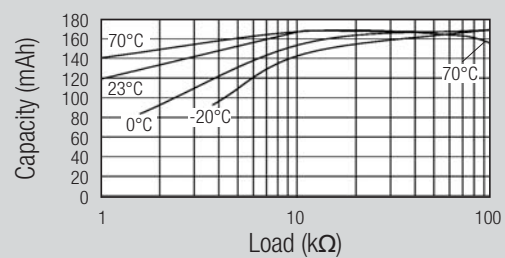

Cell capacity at various loads

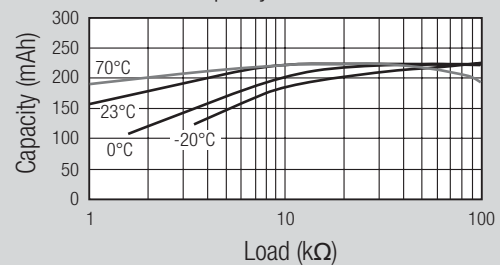

# Coin Cells

## Standard naked coin cells

**CR2032**  Rated capacity: 235 mAh  
Average weight: 2.8 g

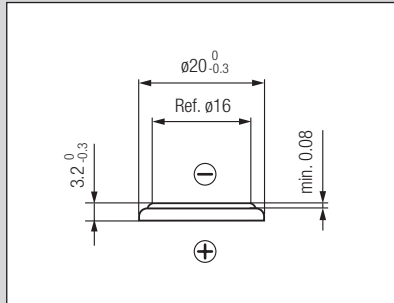

Discharge performance at 23°C

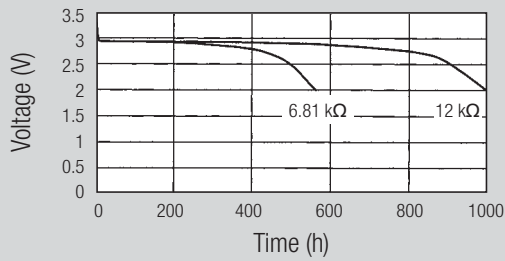

Discharge performance at 23°C

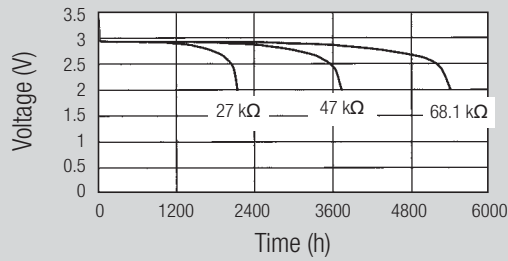

Temperature performance

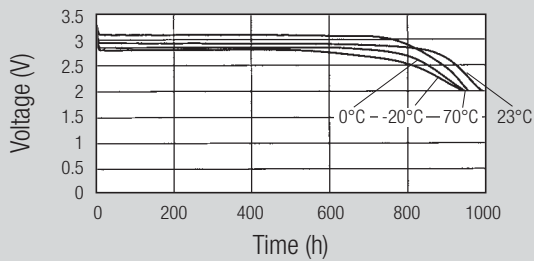

Cell capacity at various loads

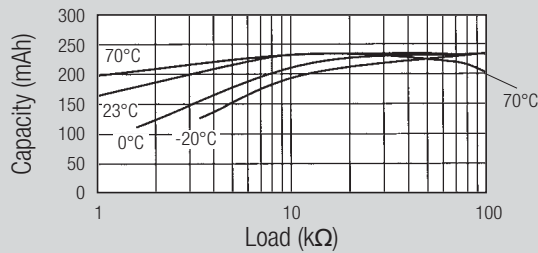

**CR2320**  Rated capacity: 150 mAh  
Average weight: 2.7 g

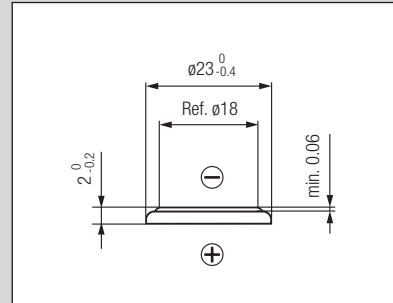

Discharge performance at 23°C

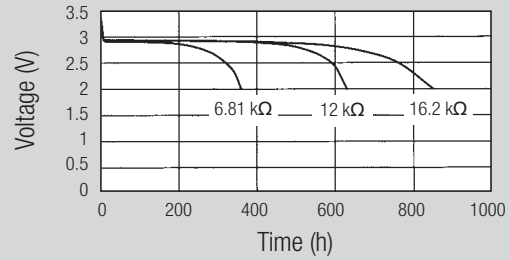

Discharge performance at 23°C

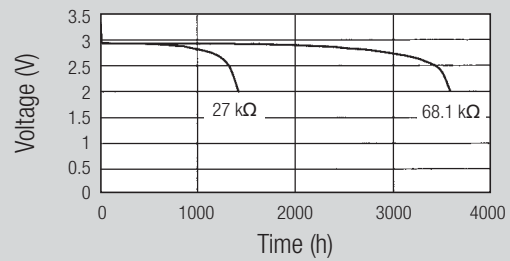

Temperature performance

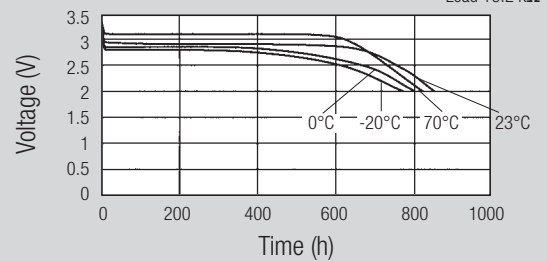

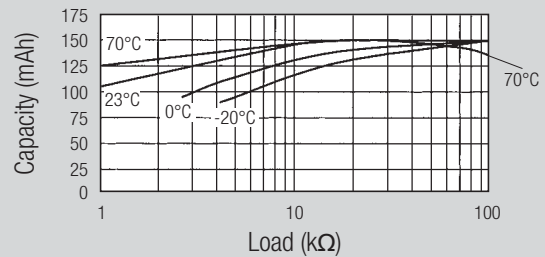

Cell capacity at various loads







**CR2325**  Rated capacity: 190 mAh  
Average weight: 3.0 g

**CR2430**  Rated capacity: 285 mAh  
Average weight: 4.1 g

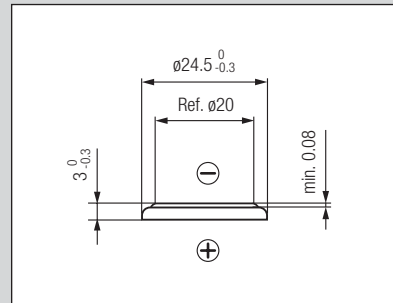
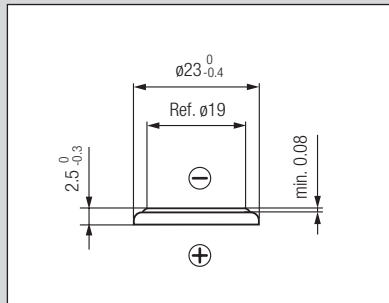

Discharge performance at 23°C

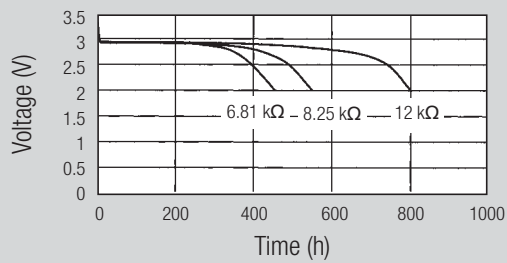

Discharge performance at 23°C

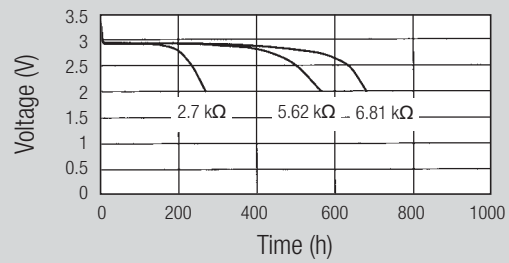

Discharge performance at 23°C

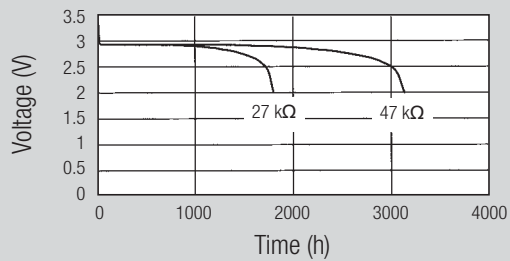

Discharge performance at 23°C

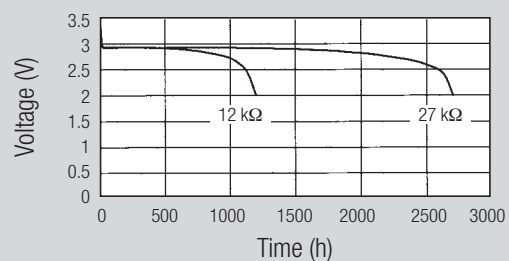

Temperature performance Load 12 kΩ

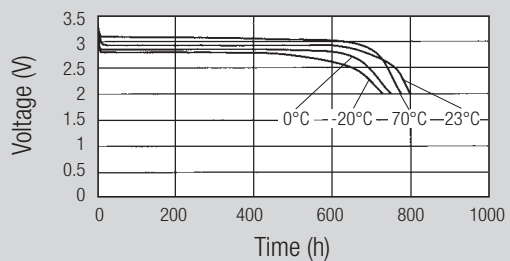

Temperature performance Load 12 kΩ

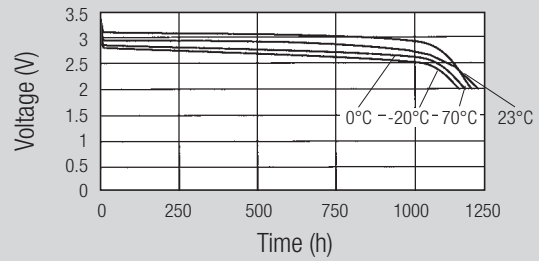

Cell capacity at various loads

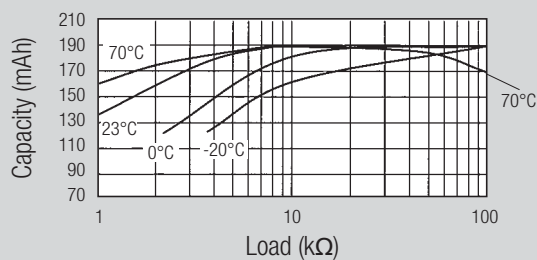

Cell capacity at various loads

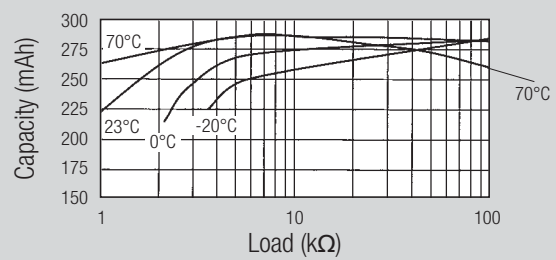

# Coin Cells

Standard naked coin cells



**CR2450N**  Rated capacity: 540 mAh  
Average weight: 5.9 g

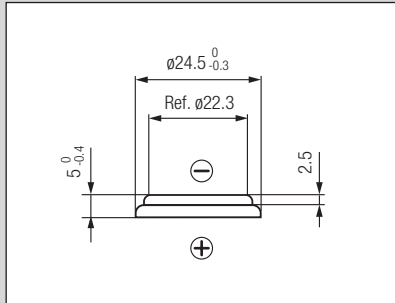

Discharge performance at 23°C

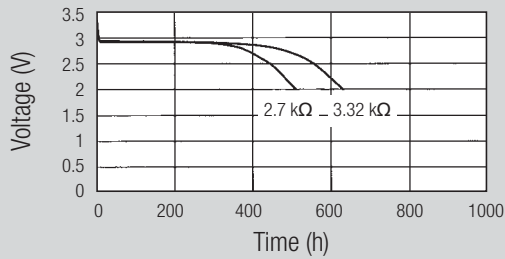

Discharge performance at 23°C

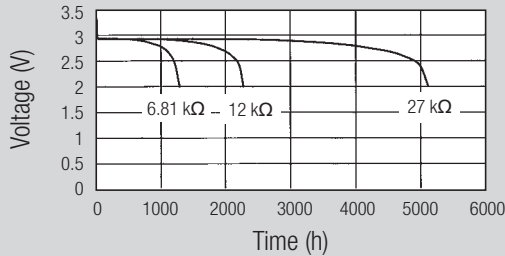

Temperature performance Load 6.81 kΩ

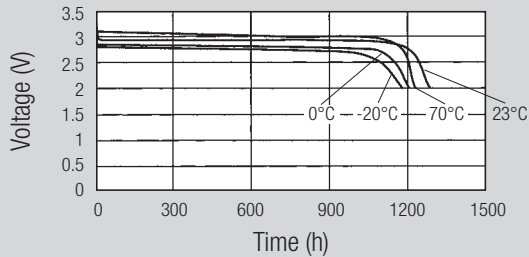

Cell capacity at various loads

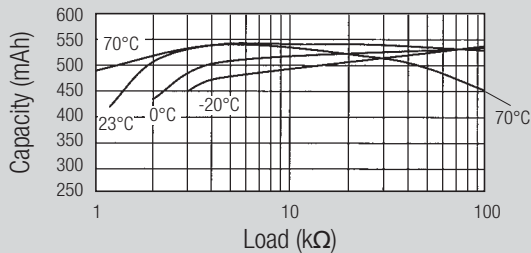

**CR2477N** \* Rated capacity: 950 mAh  
Average weight: 8.2 g

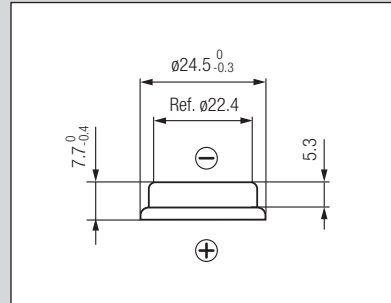

Discharge performance at 23°C

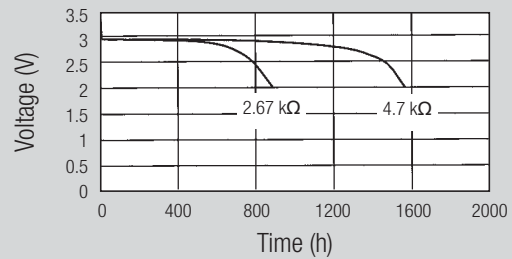

Discharge performance at 23°C

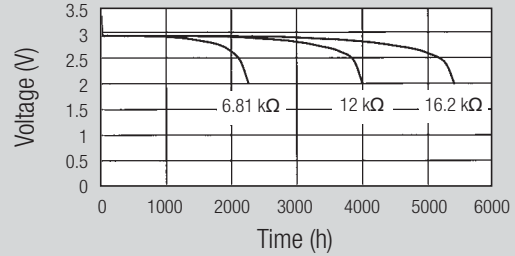

Temperature performance Load 4.7 kΩ

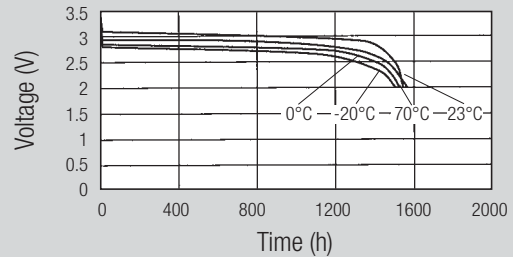

Cell capacity at various loads

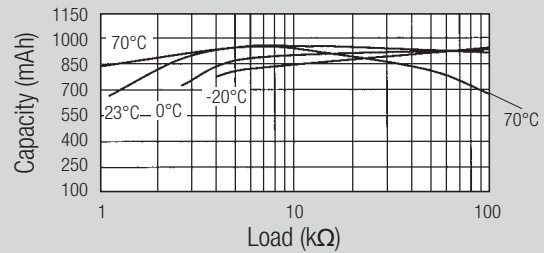

\* Battery is not user replaceable

# Coin Cells

## High temperature coin cells

In order to respond to the growing demand for miniaturized, primary power sources for applications which are operating in critical temperature conditions (-40/+125°C), Renata developed a new concept of lithium coin cell, able to withstand exposure periods to these **extreme temperatures**.

By means of advanced CAE simulations and taking advantage of the profound expertise about material science offered by partner companies within the Swatch Group, a refined battery design was defined by Renata R&D scientist.

The innovative features of the new battery include reinforced case material and a tighter crimp-sealing, so to **minimize cell bulging** at high temperature. Plastic components have been updated by means of technical polymer materials, showing high structural stability at high temperature.

CAE simulation of CR2450N at 120°C – cell is severely bulged and leakage paths are created.

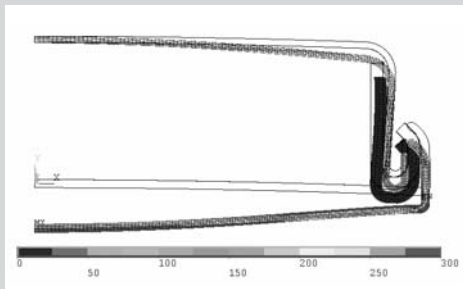

Prototypes of the new battery concept have been extensively characterised in extreme environmental conditions and different load profiles at Renata R&D facilities in Switzerland, proving the battery reliability in extended temperature ranges of application.

**The Renata CR2450HT** is the first of the new generation of high temperature lithium coin cells to be produced in mass-scale, strongly positioned in the coin cell market for electronic applications operating in the most demanding environments. The CR2450HT also shows **excellent responses to the strict requirements of the automotive industry** (vibration, mechanical shock and centrifugal force tests).

The new high temperature cell can be custom-tabbed in order to fit every application.

CAE simulation of CR2450HT at 120°C – cell bulging is negligible, the cell remains tightly sealed

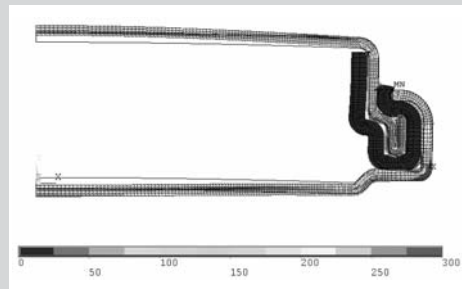

# Coin Cells

## High temperature coin cells

### General characteristics

- Electrochemical system Li/MnO<sub>2</sub>
- Operating temperature range: -40/+125°C
- Storage temperature up to 100°C
- Self-discharge: less than 1% per year at 23°C
- Shelf life: up to 10 years at max. 23°C
- Stable voltage during shelf life
- Superior leakage resistance
- Contains no heavy metals

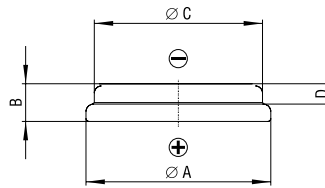

### Dimensions and weights

Model	Dimensions (mm)				Weight (g)	Part. No.*
	A (max.)	B (max.)	C (max.)	D (max.)		
CR2450HT	24.5	5.0	21.1	1.4	6.7	701700

\*Packaging: Industrial Bulk (IB-Trays)

### Electrical characteristics

Model	Nominal capacity (mAh)	Standard <sup>1)</sup> discharge current (mA)	Max. continuous discharge current <sup>2)</sup> (mA)
CR2450HT	490	0.8	3.0

### CR2450HT

Characteristic curve at 23°C

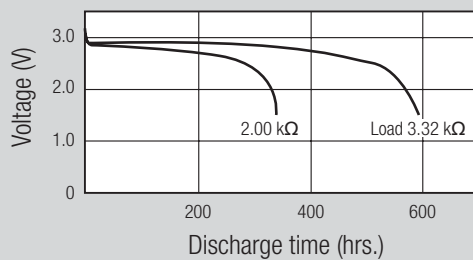

recovered capacity<sup>1)</sup> after storage at high temp.

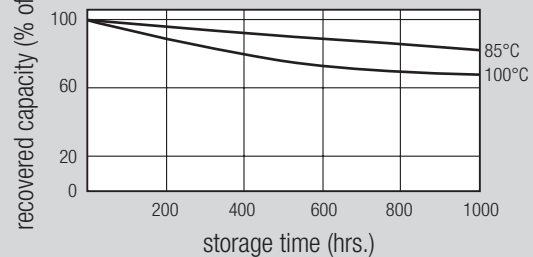

comparison height increase at 120°C

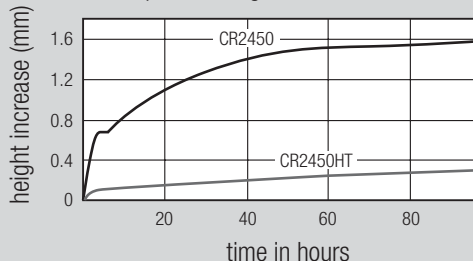

1) Standard discharge current: 100% of nominal capacity is obtained by discharging the cells at this current rates.

2) The maximum current is determined for a yield of 70% of the nominal capacity with a cut-off voltage of 2.0V, at 23°C. For currents exceeding those given above or pulsed current, please contact Renata.

# Coin Cells

## Packaging options

### Coin cells can be supplied in different packaging

#### Industrial Bulk multi-cell plastic trays

Packaging Code: IB<sup>1</sup>



Industrial Bulk packaging is the standard packaging for manufacturers.

The number of coin cells per plastic tray depends on the respective model. So does the number of plastic trays per shrink pack.

#### Singly packaged coin cells in blistered Card Units

Packaging Code: CU<sup>2</sup>

Card Unit packaging is e.g. used in replacement and retail business. There is one coin cell in a Card Unit, ten Card Units in a small box and ten small boxes in a bigger box.



#### Five coin cells packaged in blistered Tear Strips

Packaging Code: TS



Tear Strip packaging is e.g. used in retail or DIY stores. There are five coin cells in a Tear Strip, four Tear Strips in a small box and five small boxes in a bigger box.

#### Blistered multi-cell Bulk Tray

Packaging Code: BT



Bulk Tray packaging is e.g. used by small internet or catalogue distributors. The number of coin cells per Bulk Tray depends on the respective model. So does the number of plastic trays per cardboard box.

<sup>1</sup> Example: The Renata Part Name of CR2032 coin cells in industrial bulk packaging is "CR2032.IB".

<sup>2</sup> Example: The Renata Part Name of singly packaged CR1616 coin cells in card units is "CR1616.CU".

# Coin Cells with Tabs

Two pins horizontal mounting



renata  
batteries

Catalogue of two-pins standard tabbed coin cells for horizontal mounting on PCBs.

## Features

- Excellent solderability thanks to solder-plated areas
- Suitable for wave-soldering

## Specifications

- Solder contacts stainless steel AISI 301, thickness 0.15 mm
- tin-plated solder area lead free (>99.9% Sn) plated throughout, thickness min. 5 µm. Solderability according to MIL-STD 883C, method 2003.3

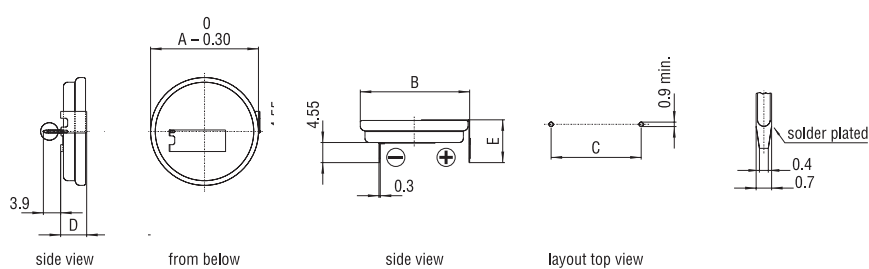

Model	Nominal Capacity (mAh)	Max. Dimensions (mm)					Weight (g)	Part.No.*
		A	B	C	D	E		
CR1216FH-LF	25	12.50	12.70	11.00	2.40	6.30	0.9	701062
CR1220FH-LF	38	12.50	12.70	11.00	2.80	6.70	1.0	701063
CR1225FH-LF	48	12.50	12.70	11.00	3.30	7.20	1.1	701065
CR1616FH-LF	50	16.00	16.20	12.70	2.40	6.30	1.3	701382
CR1620FH-LF	68	16.00	16.20	12.70	2.80	6.70	1.4	701067
CR1632FH-LF	125	16.00	16.20	11.00	3.90	7.80	2.0	701069
CR1632FH1-LF	125	16.00	16.20	15.20	3.90	7.80	2.0	701070
CR2016FH MFR	90	20.00	20.20	15.20	2.40	6.30	1.9	701591
CR2016FH-LF	80	20.00	20.20	15.20	2.40	6.30	1.9	701072
CR2016FH1 MFR	90	20.00	20.35	20.40	2.40	6.30	1.9	701593
CR2016FH1-LF	80	20.00	20.35	20.40	2.40	6.30	1.9	701239
CR2025FH MFR	165	20.00	20.20	15.20	3.30	7.20	2.7	701595
CR2025FH-LF	170	20.00	20.20	15.20	3.30	7.20	2.5	701073
CR2025FH1 MFR	165	20.00	20.20	20.40	3.30	7.20	2.7	701596
CR2025FH1-LF	170	20.00	20.20	20.40	3.30	7.20	2.5	701074
CR2032FH MFR	225	20.00	20.20	15.20	3.90	7.80	3.0	701599
CR2032FH-LF	235	20.00	20.20	15.20	3.90	7.80	3.0	701077
CR2032FH0 MFR	225	20.00	20.20	10.35	3.90	7.80	3.0	701600
CR2032FH0-LF	235	20.00	20.20	10.35	3.90	7.80	3.0	701390
CR2032FH1 MFR	225	20.00	20.20	20.40	3.90	7.80	3.0	701601
CR2032FH1-LF	235	20.00	20.20	20.40	3.90	7.80	3.0	701078
CR2032FH2 MFR	225	20.00	20.20	22.50	3.90	7.80	3.0	701603
CR2032FH2-LF	235	20.00	20.20	22.50	3.90	7.80	3.0	701237
CR2325FH-LF	190	23.00	23.20	20.40	3.30	7.20	3.2	701085
CR2430FH-LF	285	24.50	24.70	20.40	3.90	7.80	4.3	701089
CR2430FH1-LF	285	24.50	24.70	15.20	3.90	7.80	4.3	701090
CR2450NFH-LF	540	24.50	24.70	20.40	5.80	9.70	6.1	701095
CR2477NFH-LF	950	24.50	24.70	20.40	8.50	12.40	8.4	701100

\*Packaging: Industrial Bulk (IB-Trays)

# Coin Cells with Tabs

Three pins horizontal mounting



renata  
batteries

Catalogue of three-pins standard tabbed coin cells for horizontal mounting on PCBs.

## Features

- Excellent solderability thanks to solder-plated areas
- Suitable for wave-soldering

## Specifications

- Solder contacts stainless steel AISI 301, thickness 0.15 mm
- tin-plated solder area plated throughout, thickness min. 5 µm. Solderability according to MIL-STD 883C, method 2003.3

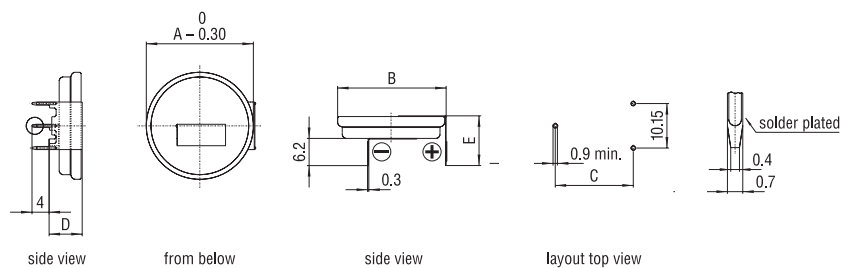
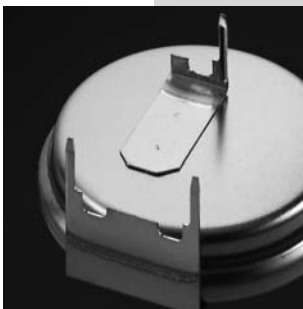

Model	Nominal Capacity (mAh)	Max. Dimensions (mm)					Weight (g)	Part.No.*
		A	B	C	D	E		
CR1632RH-LF	125	16.00	16.35	15.20	5.45	9.45	2.0	701238
CR2016RH MFR	90	20.00	20.20	15.20	3.95	7.95	2.0	701594
CR2016RH-LF	80	20.00	20.20	15.20	3.95	7.95	2.0	701380
CR2025RH MFR	165	20.00	20.20	15.20	4.85	8.85	2.6	701597
CR2025RH-LF	170	20.00	20.20	15.20	4.85	8.85	2.6	701075
CR2032RH MFR	225	20.00	20.20	15.20	5.45	9.45	3.1	701604
CR2032RH-LF	235	20.00	20.20	15.20	5.45	9.45	3.1	701080
CR2032RH1 MFR	225	20.00	20.20	17.80	5.45	9.45	3.1	701605
CR2032RH1-LF	235	20.00	20.20	17.80	5.45	9.45	3.1	701081
CR2032RH2 MFR	225	20.00	20.35	20.40	5.45	9.45	3.0	701724
CR2032RH2-LF	235	20.00	20.35	20.40	5.45	9.45	3.0	701082
CR2325RH-LF	190	23.00	23.20	17.80	4.85	8.85	3.3	701087
CR2430RH-LF	285	24.50	24.70	17.80	5.45	9.45	4.4	701092
CR2430RH1-LF	285	24.50	24.70	20.40	5.45	9.45	4.4	701093
CR2450NRH-LF	540	24.50	24.70	17.80	7.35	11.35	6.2	701097
CR2450NRH1-LF	540	24.50	24.70	20.40	7.35	11.35	6.2	701098
CR2477NRH-LF	950	24.50	24.70	17.80	10.05	14.05	8.5	701103

\*Packaging: Industrial Bulk (B-Trays)

# Coin Cells with Tabs

Two pins vertical mounting



renata  
batteries

Catalogue of two-pins standard tabbed coin cells for vertical mounting on PCBs.

## Features

- Excellent solderability thanks to solder-plated areas
- Suitable for wave-soldering

## Specifications

- Solder contacts stainless steel AISI 301, thickness 0.15 mm
- tin-plated solder area plated throughout, thickness min. 5 µm. Solderability according to MIL-STD 883C, method 2003.3

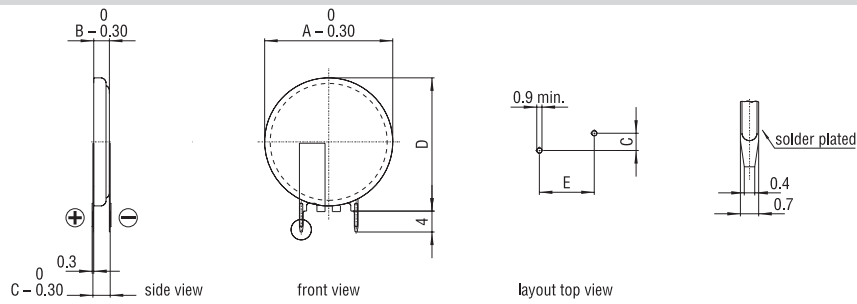

Model	Nominal Capacity (mAh) <sup>1</sup>	Max. Dimensions (mm)					Weight (g)	Part.No.*
		A	B	C	D	E		
CR1025FV-LF	30	10.00	2.50	2.80	11.00	5.08	0.8	701060
CR1025FV1-LF <sup>1)</sup>	30	10.00	2.50	2.80	11.00	5.08	0.8	701064
CR1216FV-LF	25	12.50	1.60	1.90	13.60	5.08	0.9	701370
CR1220FV-LF	38	12.50	2.00	2.30	13.50	5.08	1.0	701061
CR1225FV-LF	48	12.50	2.50	2.80	13.50	5.08	1.1	701066
CR1616FV-LF	50	16.00	1.60	1.90	17.00	5.08	1.3	701381
CR1620FV-LF	68	16.00	2.00	2.30	17.00	5.08	1.4	701068
CR1632FV-LF	125	16.00	3.20	3.50	17.00	5.08	2.0	701071
CR2016FV MFR	90	20.00	1.60	1.60	21.10	10.50	2.0	701426
CR2016FV-LF	80	20.00	1.60	1.60	21.10	10.50	2.0	701725
CR2032FV MFR	225	20.00	3.20	3.50	21.00	10.50	3.0	701606
CR2032FV-LF	235	20.00	3.20	3.50	21.00	10.50	3.0	701079
CR2320FV-LF	150	23.00	2.00	2.30	24.00	10.50	2.9	701084
CR2325FV-LF	190	23.00	2.50	2.80	24.00	10.50	3.2	701086
CR2430FV-LF	285	24.50	3.00	3.30	25.50	10.50	4.3	701091
CR2450NFV-LF	540	24.50	5.00	5.80	25.50	10.50	6.1	701096
CR2477NFV-LF	950	24.50	7.70	8.00	25.50	10.50	8.4	701101

\*Packaging: Industrial Bulk (IB-Trays)

<sup>1</sup> CR1025FV1-LF has the same dimensions as CR1025FV-LF but reverse polarity.



# Coin Cells with Tabs

## Three pins vertical mounting

Catalogue of three-pins standard tabbed coin cells for vertical mounting on PCBs.

### Features

- Excellent solderability thanks to solder-plated areas
- Suitable for wave-soldering

### Specifications

- Solder contacts stainless steel AISI 301, thickness 0.15 mm
- tin-plated solder area plated throughout, thickness min. 5 µm. Solderability according to MIL-STD 883C, method 2003.3

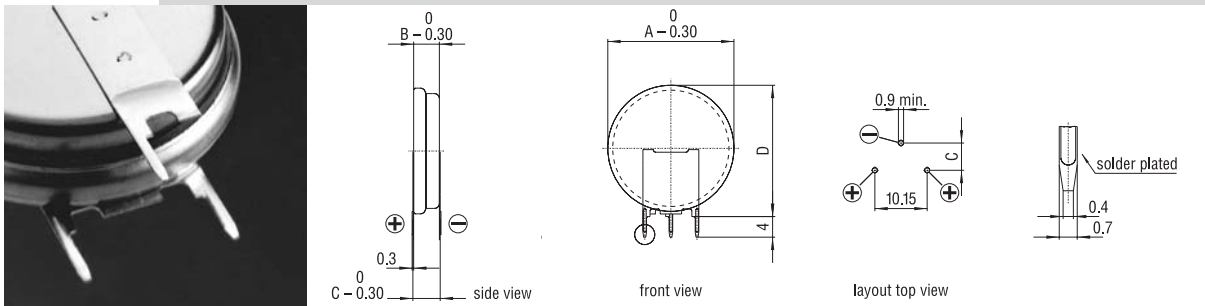

Model	Nominal Capacity (mAh)	Max. Dimensions (mm)				Weight (g)	Part.No.*
		A	B	C	D		
CR2025RV MFR	165	20.00	2.50	2.80	21.00	2.8	701598
CR2025RV-LF	170	20.00	2.50	2.80	21.00	2.6	701076
CR2032RV MFR	225	20.00	3.20	3.50	21.00	3.1	701607
CR2032RV-LF	235	20.00	3.20	3.50	21.00	3.1	701083
CR2325RV-LF	190	23.00	2.50	2.80	24.00	3.3	701088
CR2430RV-LF	285	24.50	3.00	3.30	25.50	4.4	701094
CR2450NRV-LF	540	24.50	5.00	5.30	25.50	6.2	701099
CR2477NRV-LF	950	24.50	7.70	8.00	25.50	8.5	701104

\*Packaging: Industrial Bulk (IB-Trays)

# Coin Cells with Tabs

## Isotan<sup>1)</sup> tabs



Catalogue of two-pins, Isotan<sup>1)</sup>-tabbed coin cells for horizontal mounting on PCBs.

### Features

- Good solderability
- Suitable for wave-soldering

### Specifications

- Tab material: Isotan (54% Cu, 44% Ni, Mn)

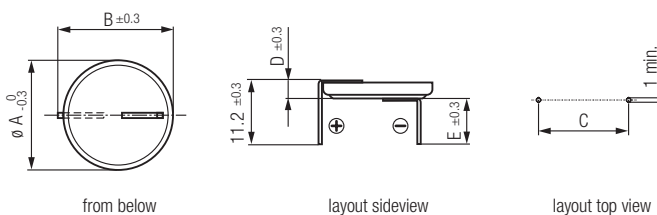

Model	Nominal Capacity (mAh)	Dimensions (mm)					Weight (g)	Part.No.*
		A	B	C	D	E		
CR1225AH	48	12.50	13.3	11.0	3.10	7.6	1.1	700772
CR1632AH1	125	16.00	17.0	15.2	3.80	7.6	2.0	700534
CR2025AH MFR	165	20.00	21.0	15.2	3.10	7.6	2.7	701720
CR2025AH	170	20.00	21.0	15.2	3.10	7.6	2.5	700310
CR2032AH MFR	225	20.00	21.0	15.2	3.85	7.6	3.0	701721
CR2032AH	235	20.00	21.0	15.2	3.85	7.6	3.0	700771
CR2032AH0 MFR	225	20.00	21.0	10.35	3.85	7.6	3.0	701722
CR2032AH0	235	20.00	21.0	10.35	3.85	7.6	3.0	700324
CR2032AH1 MFR	225	20.00	21.0	20.4	3.85	7.6	3.0	701723
CR2032AH1	235	20.00	21.0	20.4	3.85	7.6	3.0	700325
CR2430AH	285	24.50	25.3	20.4	3.60	7.6	4.3	700360
CR2450NAH	540	24.50	25.3	20.4	5.60	5.6	6.1	700378
CR2477NAH	950	24.50	25.3	20.4	8.30	3	8.3	700393

\*Packaging: Industrial Bulk (B-Trays)

1) Isotan® is a registered trademark of Isabellenhütte Heusler GmbH & Co. KG.

# Coin Cells with Tabs

## Packaging options

All tabbed coin cells are supplied in the following packaging:

### **Industrial Bulk multi-cell plastic trays**

Packaging Code: **IB**

Industrial Bulk packaging is the standard packaging for manufacturers.

The number of tabbed coin cells per plastic tray depends on the respective model. So does the number of plastic trays per shrink pack.

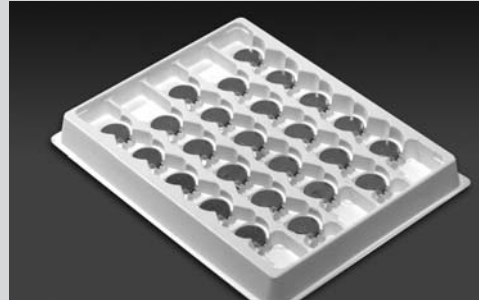

# Battery Holders

## Surface Mounting Technology (SMT)



renata  
batteries

### Horizontal mounting

#### Features

- easy and fast replacement of the battery
- designed for automatic pick&place mounting
- safe retention of coin cell
- automated battery mounting possible
- clear separation of connections
- protection against short-circuits
- protection against inverse polarity (polarized)
- protection against leak currents
- robust design

#### Specifications

- Holder material: heat-resistant, glass fibre filled LCP
- Flammability rating UL 94 V-0
- Battery contacts: spring stainless steel AISI 301, nickel-plated throughout, thickness 10  $\mu\text{m}$ . Solder area tin-plated throughout, thickness 10  $\mu\text{m}$ .
- Contact resistance between contacts and the cell is less than 100 m $\Omega$  (measured through AC 1kHz; depending on the case material of the cell).

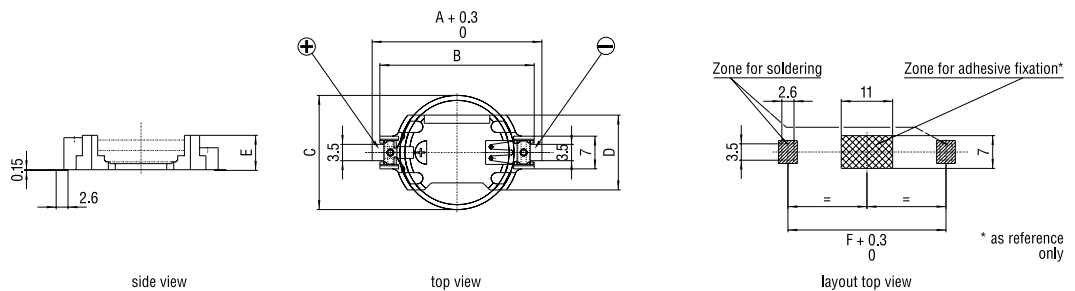
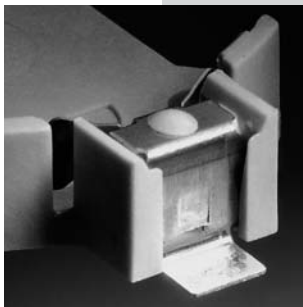

### Dimensions

Model	For use with Renata cell	Dimensions (mm)						Weight (g)	Part.No.*
		A	B	C	D	E	F		
SMTU357-LF	357 (SR44W)	23.6	19.9	11.6	12.0	7.55	21.0	0.85	701132
SMTU1220-LF	CR1220	23.7	20.3	12.5	12.7	4.8	21.1	0.80	701114
SMTU1225-LF	CR1225	23.7	20.3	12.5	12.7	4.8	21.1	0.70	701115
SMTU1632-LF	CR1632	27.7	24.3	16.0	14.5	5.4	25.1	0.80	701130
SMTU2032-LF	CR2032	32.0	28.5	20.0	16.1	5.4	29.3	0.95	701116
SMTU2430-LF	CR2430	36.5	33.0	24.5	16.1	4.9	33.8	1.05	701117
SMTU2450N-LF	CR2450N	36.6	33.0	24.5	16.1	7.5	33.8	1.45	701118
SMTU2477N-LF	CR2477N	36.7	33.0	24.5	16.1	10.3	33.8	1.65	701119
SM2X2016-LF	CR2016	32.0	28.5	20.0	16.1	5.4	29.3	0.95	701113

\*Packaging: Industrial Bulk (IB-Trays)

# Battery Holders

## Through-hole mounting



renata  
batteries

### Horizontal mounting

#### Features

- easy and fast replacement of the battery
- designed for automatic pick&place mounting
- safe retention of coin cell
- automated battery mounting possible
- clear separation of connections
- protection against short-circuits
- protection against inverse polarity (polarized)
- protection against leak currents
- robust design

#### Specifications

- Holder material: heat-resistant, glass fibre filled LCP
- Flammability rating UL 94 V-0
- Battery contacts: spring stainless steel AISI 301, nickel-plated throughout, thickness 10  $\mu\text{m}$ . Solder area tin-plated throughout, thickness 10  $\mu\text{m}$ .
- Contact resistance between contacts and the cell is less than 100 m $\Omega$  (measured through AC 1kHz; depending on the case material of the cell).

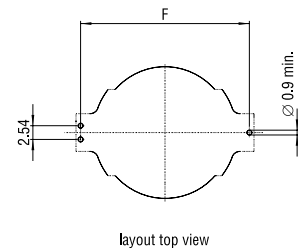
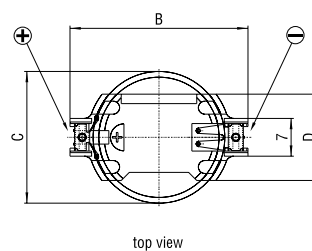
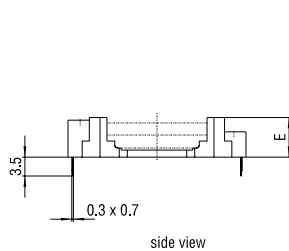
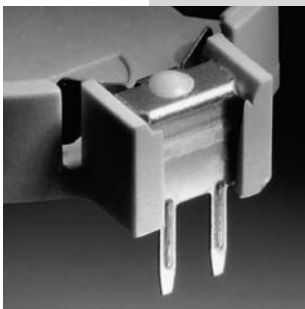

### Dimensions

Model	For use with Renata cell	Dimensions (mm)					Weight (g)	Part.No.*
		B	C	D	E	F		
HU357-LF	357 (SR44W)	19.9	11.6	12.0	7.4	18.35	0.84	701133
HU1225-LF	CR1225	20.3	12.5	12.7	4.6	18.7	0.70	701105
HU1632-LF	CR1632	24.3	16.0	14.5	5.2	22.7	0.80	701131
HU2032-LF	CR2032	28.5	20.0	16.1	5.2	26.9	0.95	701106
HU2430-LF	CR2430	33.0	24.5	16.1	4.7	31.5	1.05	701107
HU2450N-LF	CR2450N	33.0	24.5	16.1	7.3	31.5	1.45	701108
HU2477N-LF	CR2477N	33.0	24.5	16.1	10.1	31.5	1.65	701109

\*Packaging: Industrial Bulk (IB-Trays)

# Battery Holders

## Through-hole mounting



renata  
batteries

### Vertical mounting

VBH2032-1 - Vertical battery holder for Renata coin cell CR2032

#### Features

- Small PCB footprint
- easy and fast replacement of the battery
- safe retention of coin cell
- protection against short-circuits
- protection against inverse polarity (polarized)
- protection against leak currents
- robust design

#### Specifications

- Holder material: polyamide
- Flammability rating UL 94 V-0
- Battery contacts: spring stainless steel AISI 301, nickel-plated throughout, thickness 5 µm min.
- Solder area tin-plated throughout, thickness 10 µm
- Temperature range: -40/+85°C

### Dimensions (mm)

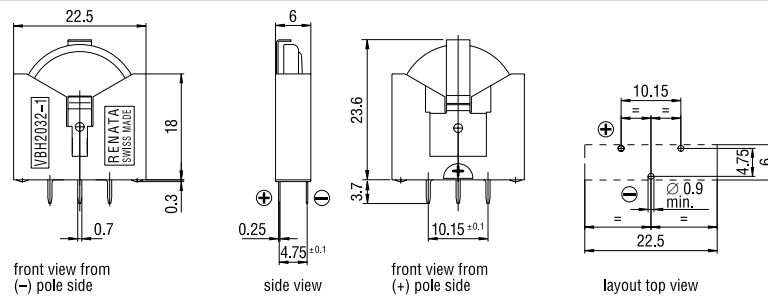

Model	For use with Battery	Weight (g)	Part. No.*
VBH2032-1	CR2032	1.6	700579

\*Packaging: Industrial Bulk (IB-Trays)

# Battery Holders

Through-hole mounting with positioning pins



Battery holders for CR2450N or CR2477N  
Vertical and horizontal versions

## Features

- easy and fast replacement of the battery
- snap-on fixing for coin cells
- safe retention of coin cell
- automated battery mounting possible
- clear separation of connections
- protection against short-circuits
- protection against inverse polarity
- protection against leak currents
- robust design
- easy and safe PCB mounting due to additional positioning pins

## Specifications

- Holder material: polyamide
- Flammability rating UL 94 V-2
- Battery contacts: Nickel 99.6 DIN 17740
- Contact resistance between contacts and the cell is less than 100mW (measured through AC 1kHz).
- Solder and positioning pins tin plated through-out (plating thickness min. 5 µm)

### NH5077-LF Vertical version

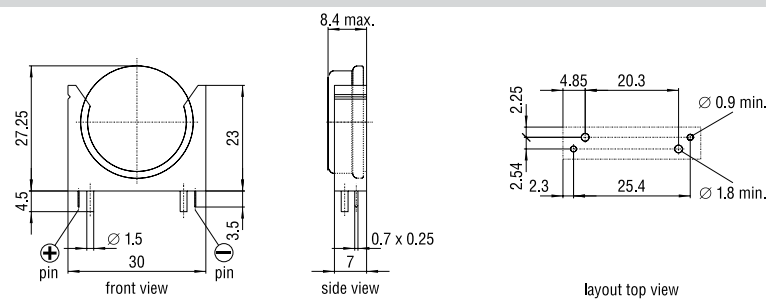

### NL5077-LF Horizontal version

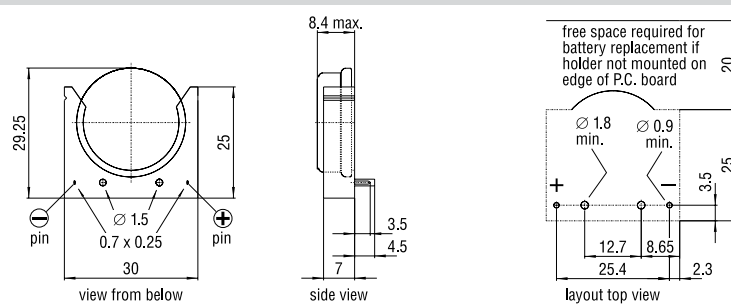
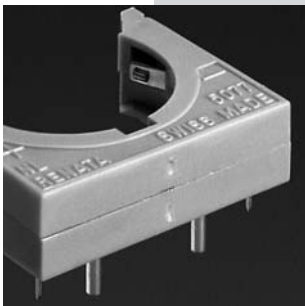

Model	For use with Battery	Weight (g)	Part.No.*
NH5077-LF	CR2450N, CR2477N	2.4	701111
NL5077-LF	CR2450N, CR2477N	2.9	701112

\*Packaging: Industrial Bulk (IB-Trays)

# Battery Holders

## Packaging options

### Battery holders can be supplied in different packaging

#### Industrial Bulk multi-cell trays

Packaging Code: **IB**

Industrial Bulk packaging is the standard packaging for manufacturers.

The number of battery holders per tray depends on the respective model. So does the number of trays per shrink pack.

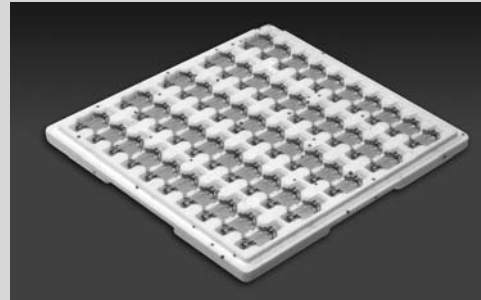

#### Tape&Reel packaging

Packaging Code: **TR**

For SMT-battery holders there is a Tape&Reel packaging solution available.

Tape&Reel packaging is ideal for high-speed, automated manufacturing lines.

The number of battery holders per reel depends on the respective model.



#### Quantity per reel:

Model	Quantity per Reel	Part.No.*
SMTU1225-LF.TR	750 pieces	701230
SMTU1632-LF.TR	520 pieces	701231
SMTU2032-LF.TR	485 pieces	701232
SMTU2430-LF.TR	490 pieces	701233
SMTU2450N-LF.TR	350 pieces	701234
SMTU2477N-LF.TR	250 pieces	701235
SM2X2016-LF.TR	485 pieces	701236

\*Packaging: Tape&Reel (TR)



# Battery Holders

## Packaging options

### Dimensions of antistatic carrier tapes:

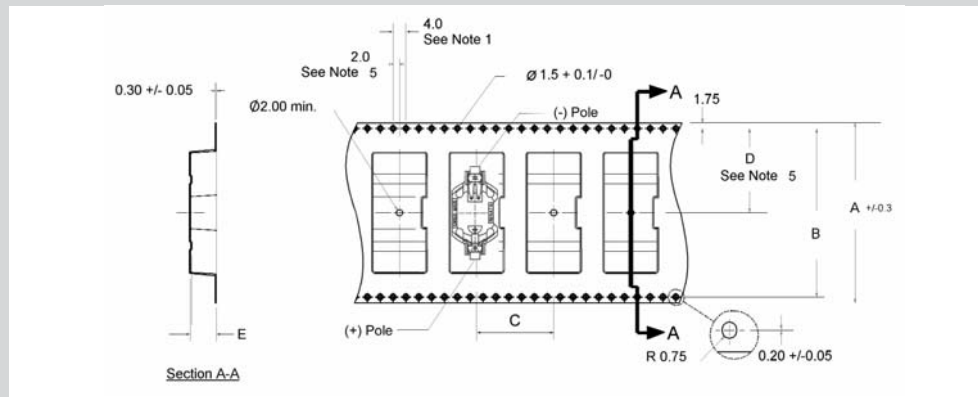

Model	Dimensions (mm)				
	A	B	C	D	E
SMTU1225-LF	44.0	40.4	16.0	20.2	5.7
SMTU1632-LF	44.0	40.4	20.0	20.2	6.1
SMTU2032-LF	44.0	40.4	24.0	20.2	6.0
SMTU2430-LF	56.0	52.4	24.0	26.2	5.7
SMTU2450N-LF	56.0	52.4	24.0	26.2	8.2
SMTU2477N-LF	56.0	52.4	24.0	26.2	10.8
SM2x2016-LF.TR	44	40.4	24	20.2	6

### Dimensions of antistatic packaging reels

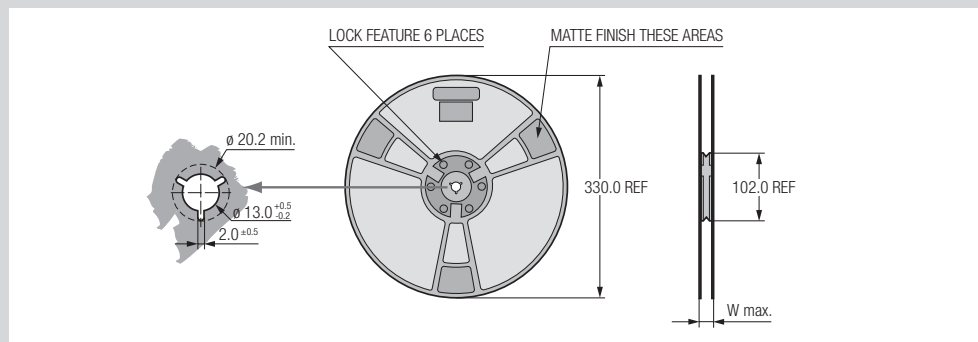

Model	Dimensions (mm)
	W max.
SMTU1225-LF	50.2
SMTU1632-LF	50.2
SMTU2032-LF	50.2
SMTU2430-LF	62.2
SMTU2450N-LF	62.2
SMTU2477N-LF	62.2
SM2x2016-LF.TR	50.2

All packaging materials comply with relevant EIA, EIAJ and IEC specifications.

- 10 sprocket hole pitch cumulative tolerance +/- .02
- Camber not to exceed 1mm in 100 mm
- Material: Black Conductive Advantek Polystyrene
- E measured from a plane on the inside bottom of the pocket to the top surface of the carrier
- Pocket position relative to sprocket hole measured as true position of pocket, not pocket hole

# Encapsulated Batteries (Power Modules)

## Overview



### Why use encapsulated batteries (Power Modules)?

RENATA Power Modules were specially designed for applications with long life expectations in a difficult environment, e.g. outdoors or under dusty or high humidity conditions. The cell is hermetically sealed in a plastic case which protects the sealing system of the cell itself against negative external influences. In addition, it reduces the evaporation of electrolyte from the battery as well as the diffusion of humidity from the environment into the cell through the polymeric plastic gasket. An ideal solution for use in off-shore property or tropical areas.

RENATA Power Modules are available as solder or plug-in versions, with or without incorporated decoupling diodes.

### Features

- hermetically sealed
- max. protection against harsh environmental conditions (hot, humid or dusty areas)
- low self-discharge
- operating and storage temperature:  $-40^{\circ}/+85^{\circ}\text{C}^{1)}$
- suitable for wave soldering
- free of heavy metals
- gold-plated plug-in pins for best contact reliability

### Specifications

- Power Module case: Polyamide
- soldering contacts: Isotan<sup>2)</sup> (55% CU, 44% Ni, Mn)

Model Matrix		With Decoupling Diodes	Without Decoupling Diodes
Horizontal mounting	For soldering	1000-1, (page 34)	175-0; 1000-0, (page 35)
	For plug-in	1000-1B, (page 36)	175-0B; 1000-0B, (page 37)
Vertical mounting	For soldering	175-2, (page 33)	338A, (page 34)

1) In applications where the Power Modul is exposed to temperatures above  $70^{\circ}\text{C}$ , please contact Renata for consultancy.

2) Isotan<sup>®</sup> is a registered trademark of Isabellenhütte Heusler GmbH & Co. KG.

# Encapsulated Batteries (Power Modules)

For soldering



## Versions for vertical mounting, with decoupling diodes

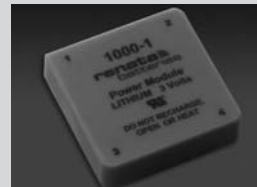
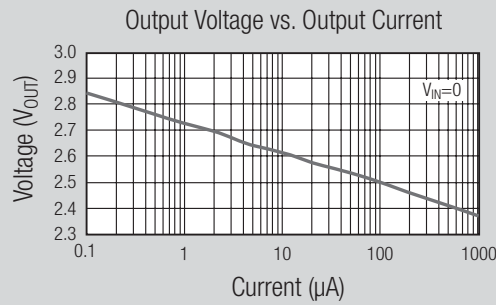
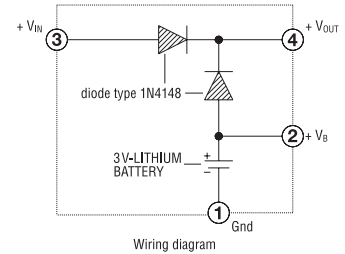
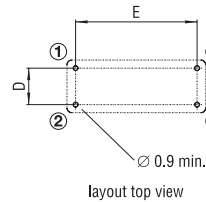
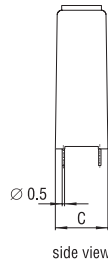
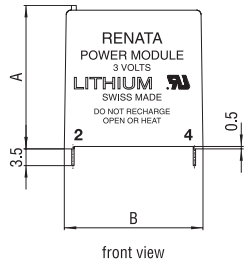
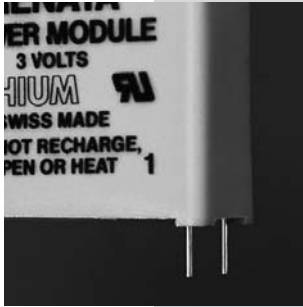

Model	Dimensions (mm)					Weight (g)	Nominal Voltage (V)	Nominal Capacity (mAh)	Standard Current (mA)	Max. cont. Current (mA)	Part.No.*
	A	B	C	D	E						
175-2	25	24	8.5	5.08	20.32	6.5	3	235	0.4	3.0	700044

\*Packaging: Industrial Bulk (IB-Trays)

# Encapsulated Batteries (Power Modules)

For soldering



## Versions for vertical mounting, without decoupling diodes.

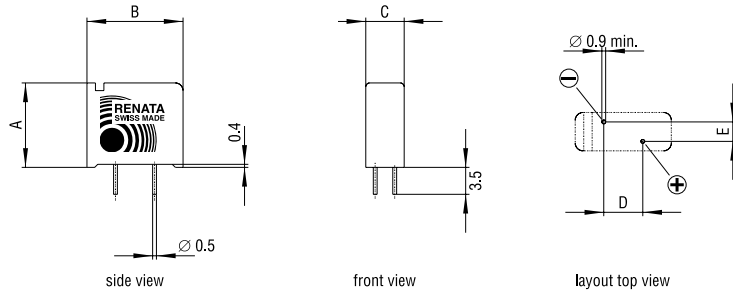
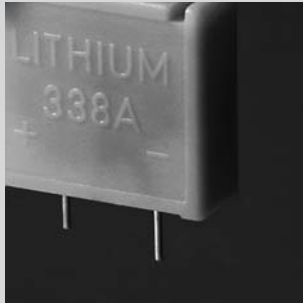

Model	Nominal Voltage (V)	Capacity (mAh)	Chemistry	Dimensions (mm)					Weight (g)	Part.No.*
				A	B	C	D	E		
338A	3	48	MnO <sub>2</sub> /Li	13.5	15.0	5.0	7.6	2.54	1.69	700101

\*Packaging: Industrial Bulk (IB-Trays)

## Versions for horizontal mounting, with decoupling diodes.

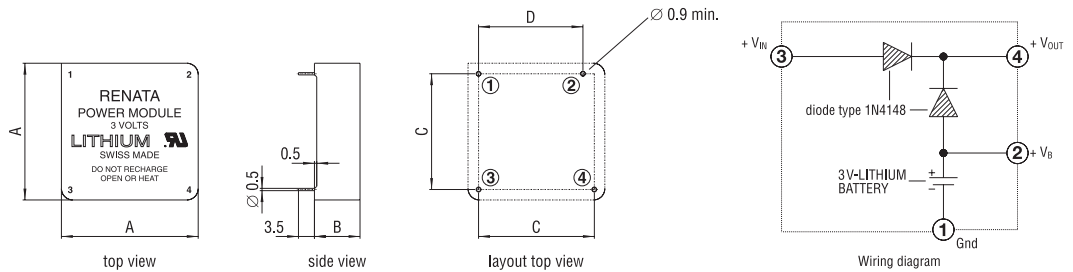
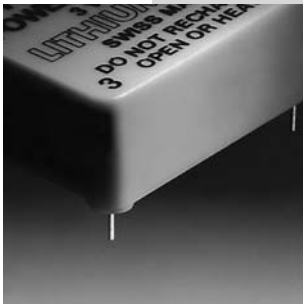

Output Voltage vs. Output Current

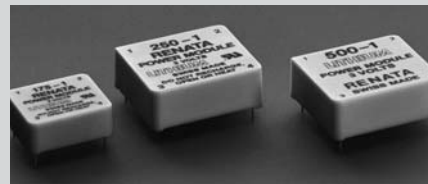
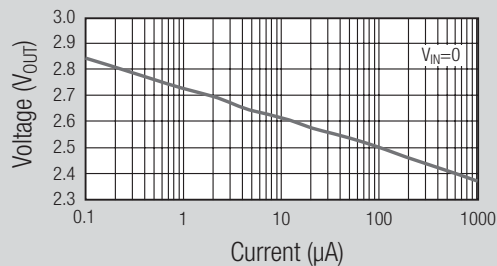

Model	Dimensions (mm)				Weight (g)	Nominal Voltage (V)	Nominal Capacity (mAh)	Standard Current (mA)	Max. cont. Current (mA)	Part.No.*
	A	B	C	D						
1000-1	30	10	25.4	22.9	15	3	950	1.0	2.5	700035

\*Packaging: Industrial Bulk (IB-Trays)

# Encapsulated Batteries (Power Modules)

For soldering



## Versions for horizontal mounting, without decoupling diodes.

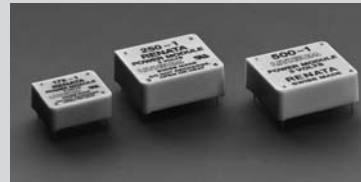
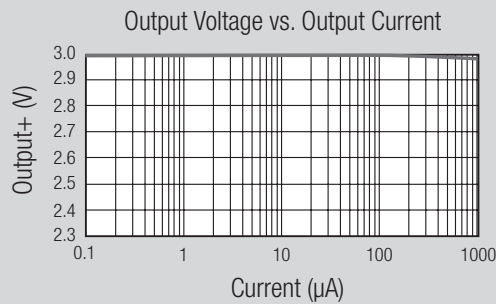
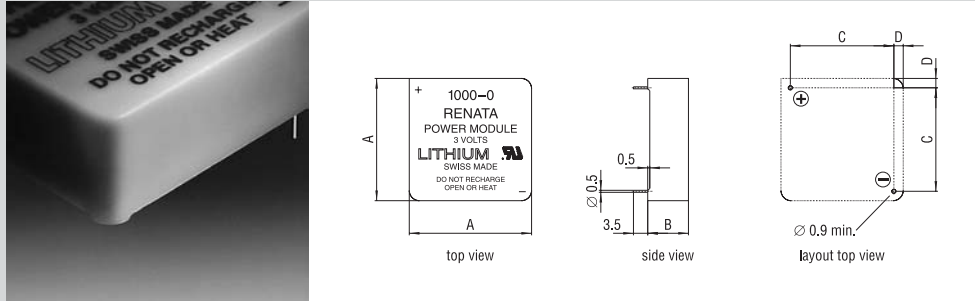

Model	Dimensions (mm)				Weight (g)	Nominal Voltage (V)	Nominal Capacity (mAh)	Standard Current (mA)	Max. cont. Current (mA)	Part.No.*
	A	B	C	D						
175-0	22	8	17.8	2.1	6.5	3	235	0.4	3.0	700040
1000-0	30	10	25.4	2.3	15	3	950	1.0	2.5	700031

\*Packaging: Industrial Bulk (IB-Trays)

# Encapsulated Batteries (Power Modules)

For plug-in



Versions for horizontal mounting, with decoupling diodes.

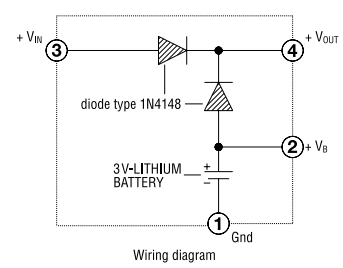
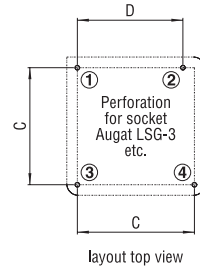
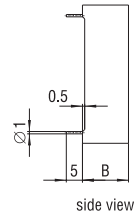
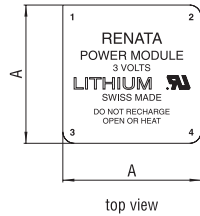
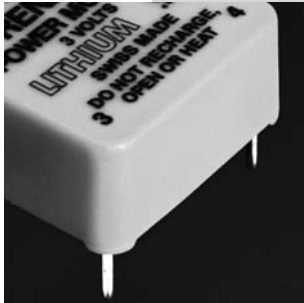

Output Voltage vs. Output Current

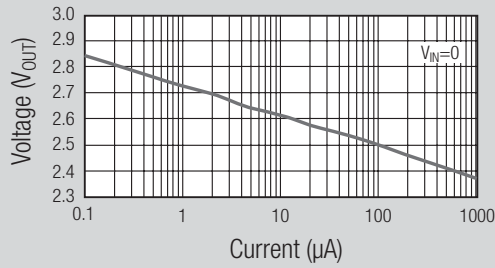

Model	Dimensions (mm)				Weight (g)	Nominal Voltage (V)	Nominal Capacity (mAh)	Standard Current (mA)	Max. cont. Current (mA)	Part.No.*
	A	B	C	D						
1000-1B	30	10	25.4	22.9	15	3	950	1.0	2.5	700036

\*Packaging: Industrial Bulk (IB-Trays)

# Encapsulated Batteries (Power Modules)

For plug-in

Versions for horizontal mounting, without decoupling diodes. 

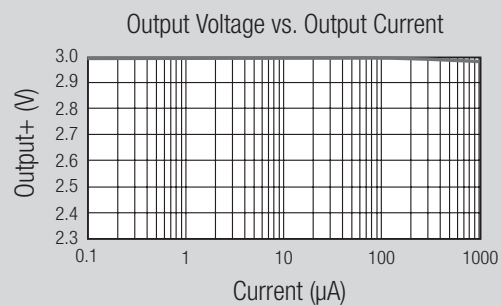
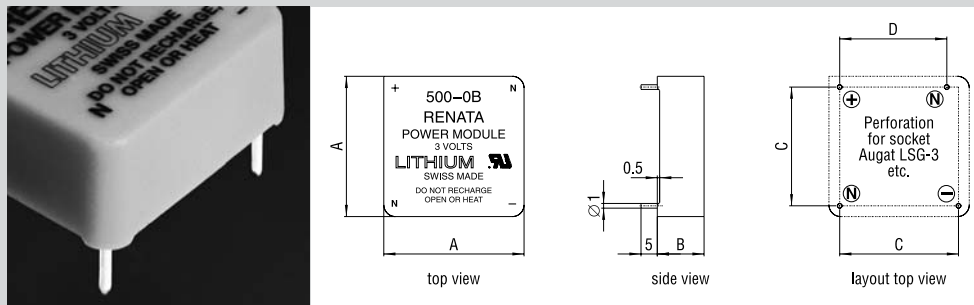

Model	Dimensions (mm)				Weight (g)	Nominal Voltage (V)	Nominal Capacity (mAh)	Standard Current (mA)	Max. cont. Current (mA)	Part.No.*
	A	B	C	D						
175-0B	22	8	17.8	15.3	6.5	3	235	0.4	3.0	700041
1000-0B	30	10	25.4	22.9	15	3	950	1.0	2.5	700033

\*Packaging: Industrial Bulk (IB-Trays)

# Encapsulated Batteries (Power Modules)

## Packaging options

**All encapsulated batteries (Power Modules) are supplied in the following packaging**

### Industrial Bulk multi-cell trays

Packaging Code: IB

Industrial Bulk packaging is the standard packaging for manufacturers.

The number of encapsulated batteries per tray depends on the respective model. So does the number of trays per shrink pack.

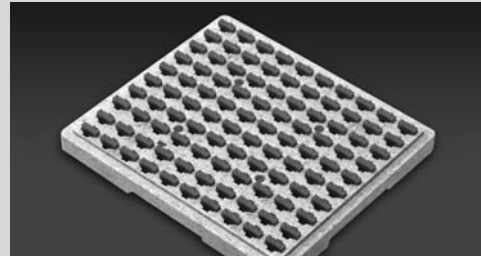



# Customized Battery Solutions

## Optional antimagnetic case material



Renata coin cells can also be supplied with **antimagnetic case material** (required from special applications like medical equipment). Some products are already available with the antima-

gnetic case (see table below).

Contact Renata if you need antimagnetic versions of other types of Renata coin cell product portfolio.

### Antimagnetic products

Model	Nominal voltage (V)	Nominal capacity (mAh)	Standard discharge current (mA)	Max. cont. discharge current (mA)	Part.No.*
CR2032AM	3	235	0.4	3.0	701730
CR2450NAM	3	540	0.8	3.0	701740

\*Packaging: Industrial Bulk (IB-Trays)

## Optional tab configuration

Apart from the standard program of lithium tabbed coin cells, Renata offers the possibility of **customized solutions of tabbed coin cells**.

You can get a prompt response to your design and manufacturing needs by contacting our

engineering team, especially devoted to customer support. **Feasibility study, prototyping and industrialization** are part of this solution-oriented, technical service.

Contact Renata sales network to get your own project!

### Examples of customized solutions

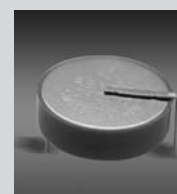
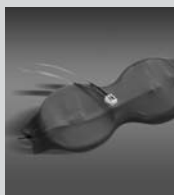

# Chemistry and Construction

## Chemistry of RENATA Li/MnO<sub>2</sub> cells

Renata CR lithium coin cells use a non-aqueous, aprotic organic electrolyte containing lithium perchlorate in a mixture of organic solvents. The proprietary formulation of the active cathode material consists of a heat-treated mixture of electrolytic MnO<sub>2</sub> and other specific components, yielding an outstanding volume/capacity ratio for this Li/MnO<sub>2</sub> system.

The cell reactions for this electrochemical system are:

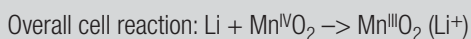
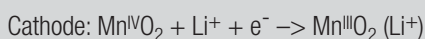
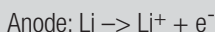

Manganese dioxide is reduced from the tetravalent to the trivalent state by lithium.

The separator system in Renata coin cells is especially designed to ensure the best performance in terms of mechanical strength, ion permeability over a wide temperature range (-40 to +100°C) and a low self-discharge rate. Additional care in cell design also minimizes self-discharge rate.

The combination of these several features provides the best performance for long life applications (back-up etc.)

## Construction of RENATA Li/MnO<sub>2</sub> cells

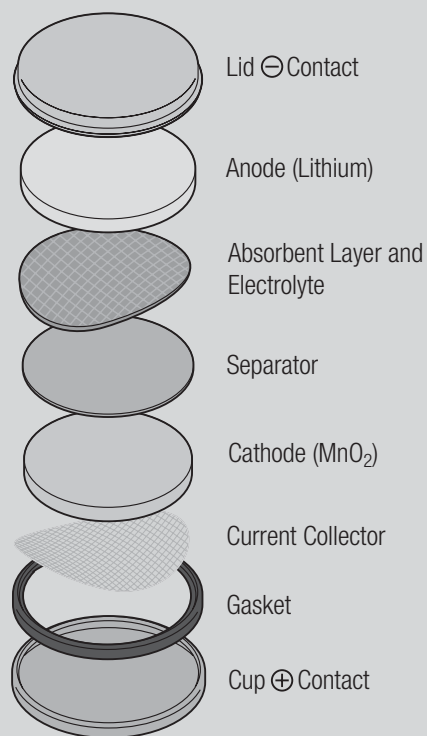
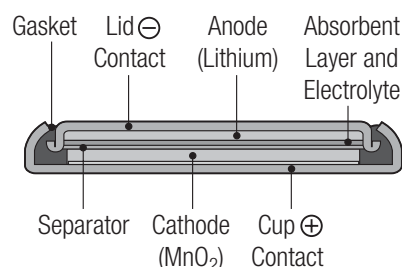

# Electrical & Temp. Performance

## Pulse discharge characteristics

RENATA Lithium batteries have excellent pulse load characteristics, for example for the transmission of radio signals by remote controls. The following diagrams show the voltage characteristics at pulse loads of 10, 20, and

50 mA during 100 ms, pulse cycle 1 second, at ambient temperature. The voltage drop under load is evident as well as the voltage recovery to almost the original level after a very short time.

Please contact Renata for further details.

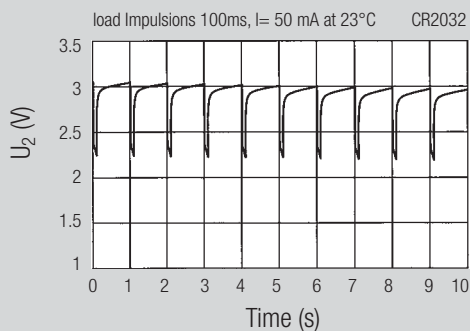
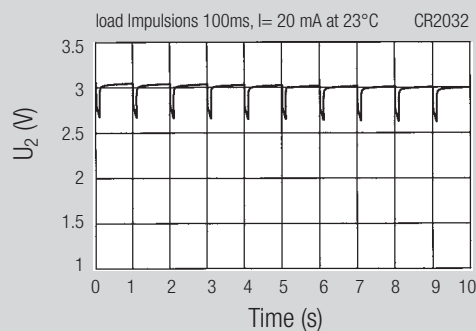
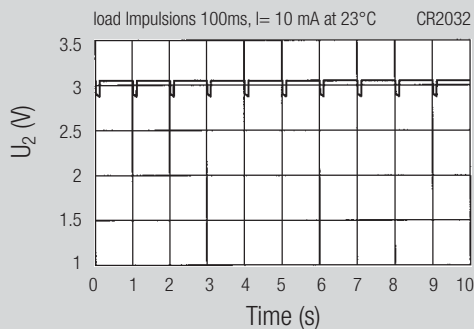

## Inverse current

Lithium primary batteries are not rechargeable. Therefore, if there is a possibility of electric current flowing from the main power source to the battery, the circuit must include two suitable blocking diodes in series or one blocking diode and one protective resistor in series (refer to drawing in chapter SAFETY GUIDELINES) Use a silicium diode of small inverse current to prevent charging. **The total amount of recharge energy due to leakage by the blocking diodes should not exceed 1% of the battery's nominal capacity during its total service life. A higher input of recharge energy may harm the battery or reduce its performance.**

Example: A CR2450N battery with a nominal capacity of 540 mAh is expected to supply power for 5 years. The amount of tolerable re-charge

energy is 5.4 mAh, corresponding to an inverse current of 0.123  $\mu$ A for the total service life<sup>1)</sup>. Consequently, a blocking diode with an inverse current not greater than 0.1  $\mu$ A should be selected. Please note that the inverse current of blocking diodes varies with temperature.

## Short circuits

When lithium batteries are short-circuited, it takes time for the battery voltage to recover, even in case of slight short-circuits. If electrical characteristics are measured while the battery is recovering, the battery may appear to be defective, but is not. Short-circuiting leads to deterioration of the cell capacity. Short-circuiting of batteries must therefore be avoided, except for wave or dip soldering. Use an instrument with a high input impedance (minimum 10 M $\Omega$ ) for measuring open circuit voltage.

<sup>1)</sup> 540 mAh \* 1% = 5.4 mAh  
5.4 mAh / (5 years \* 365 days \* 24 hours) = 0.123  $\mu$ A

# Electrical & Temp. Performance

## **Superior environmental resistance**

The combination of RENATA's sealing system and the use of organic electrolytes with low creeping tendency ensure the excellent leakage resistance of our batteries. Each production lot is subjected to a quality assurance program under difficult environmental conditions (high temperature storage, high temperature/high humidity storage, temperature cycling, etc.). RENATA batteries can be operated in any physical position.

## **Why use RENATA Lithium Power Modules**

RENATA Power Modules were specially designed for applications with long life expectations in a difficult environment, e.g. outdoors or under dusty or high humidity conditions. The cell is hermetically sealed in a plastic case which protects the sealing system of the cell itself against negative external influences. In addition, it reduces the evaporation of electrolyte from the battery as well as the diffusion of humidity from the environment into the cell through the polymeric plastic gasket, an ideal solution for use in tropical areas.

RENATA Power Modules are available as solder or plug-in versions, with or without incorporated decoupling diodes.

# Frequently Asked Questions (FAQ)

## General electrical performance

### Which values of open circuit voltage do lithium cells typically show?

The CR-type coin cells, based on the lithium/manganese dioxide electrochemical system, have a nominal voltage of 3 V. In practice, a fresh lithium cell will typically show an OCV (Open Circuit Voltage) between 3.15-3.35 V. This range of values is intended for measurements performed at room temperature; in fact, the OCV values depend on the temperature of the measurement.

After storage periods the cells may also show values outside this range, due to ageing effects (see the recommended storage conditions for lithium coin cells, also reported in this document).

### What is the internal resistance of a cell? How does it affect the performance of the cell?

From an electrical point of view, a cell is a combination of an energy source and a resistance. The internal resistance ( $R_i$ ) is a key parameter for a cell, as it determines its high-power capability (i.e. its ability of delivering its energy in a short time). The internal resistance reduces the useful voltage in applications and leads to internal heat, thus loss of energy, which increases with the square of the current.

The internal resistance of lithium cell is a sum of both ohmic contributions and of resistive contributions coming from electrochemical phenomena taking place during the discharge of the cell. By accurate selection and quality control

of materials, Renata manufacturing process minimizes the resistive factors contributing to the internal resistance of the lithium cells.

As the internal resistance includes a number of resistive contributions coming from electrochemical phenomena, each of them being characterised by a time constant, the value of internal resistance is pretty much depending from the measuring method and conditions. A simple and inexpensive method for measuring the  $R_i$  is to apply a resistive load ( $R_1$ ) to the cell and to measure the value of the cell voltage under load (CCV, Closed Circuit Voltage). The internal resistance is then calculated as:

$$R_i = (OCV - CCV) \times R_1 / CCV.$$

### Does the internal resistance changes with time, or during the cell discharge?

Generally speaking, there is a limited, physiological increase of the internal resistance of a primary cell during its service-life. In the case of lithium coin cells, the normal increase during the cell discharge is due both to ohmic factors (the distance between the electrodes increases during discharge) and to electrochemical phenomena taking place at the lithium anode (growing of interface films between lithium metal and electrolyte solution).

The increase of the overall internal resistance with increasing discharge level is reported in the figure below.

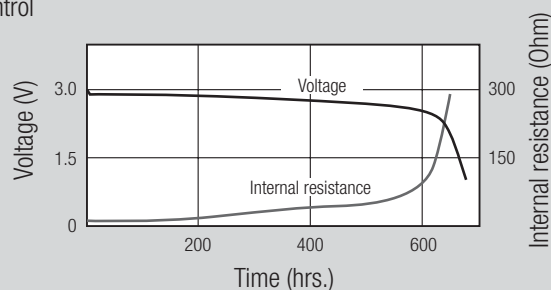

**Figure 1** Characteristic curve<sup>1</sup> of a CR2450N cell. Discharge load:  $R_1=3.32$  kOhm. Measurement of internal resistance during discharge: by applying the load  $R_2=150$  Ohm for 1s, every 3 hrs.

<sup>1</sup>) This curve is intended as typical data and not as cell specification.

# Frequently Asked Questions (FAQ)

## General electrical performance

The ageing of the cells at normal conditions (i.e. room temperature, max. 40% of relative humidity) will also lead to other physiological increases of the internal resistance, due to normal ageing phenomena taking place at the electrodes. Though of limited extent, these types of increases of the internal resistance are normally to be expected and must be also taken into account, when designing a new application.

Exposing the cells to elevated temperatures, then, can lead to further grow of the passivation films at the anode, with an additional increase of internal resistance. Furthermore, increasing the temperature above 70°C can cause the internal resistance to abnormally increase (because of electrolyte leakages and degradation phenomena). Abuse conditions such as discharge at elevated currents and short-circuit can also increase the internal resistance abnormally, because of the deterioration of cell internal components.

### Which is the voltage drop of the lithium cell during current pulse?

The voltage drop during a current pulse ( $\Delta V$ ) is the difference between the cell voltage just before applying the pulse (Voltage-high,  $V_1$ ) and the cell voltage during the pulse (Voltage-low,  $V_2$ ):

$$\Delta V = V_2 - V_1$$

It is also expressed by the formula:

$$\Delta V = R_i \times I_{\text{peak}}$$

where  $R_i$  (internal resistance) depends on the cell type and dimensions. In addition, the value of  $R_i$  depends on the temperature and on the discharge level of the cell (see related section about internal resistance). Therefore the voltage drop of the cell will be strongly affected by the temperature and by the cell's discharge level.

From the above reported formula it also follows that the voltage drop strictly depends on the applied pulse itself-particularly on the value of the pulse-current ( $I_{\text{peak}}$ ). The voltage drop is also affected by the other parameters that define a pulse-load: the pulse duration (i.e. how long the pulse current  $I_{\text{peak}}$  is applied), the pulse period (i.e. the time between two subsequent pulses), the frequency with which the pulse trains occur (i.e. how often the pulse trains are applied to the battery) and -eventually- the basis-current (i.e. the current applied between two pulse trains). The last three pulse parameters affect the voltage drop during pulse, because their settings affect the value of the cell voltage just before applying the pulse ( $V_1$ ).

An example of voltage and internal resistance behaviour during a pulse discharge is reported below (Figure 2).

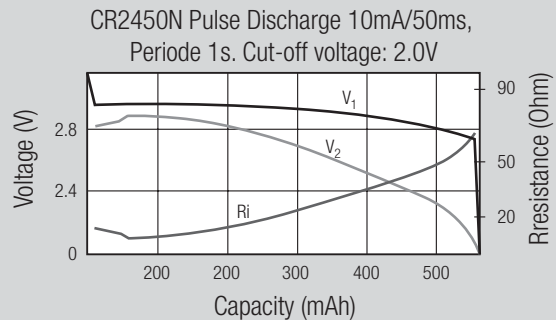

Figure 2: Pulse-current discharge characteristics<sup>1</sup> of the CR2450N cell.

1) This curve is intended as typical data and not as cell specification.

# Frequently Asked Questions (FAQ)

## General electrical performance

### **What is the maximum pulse current the lithium coin cells can handle?**

There are no specified limits for the peak current value in pulse applications; instead, current limits can be defined by means of a series of factors and practical considerations related to the electrical application, like the load profile, the cut-off voltage and the targeted service-life of the cell in the application. Electrical applications are normally regulated by a voltage threshold (cut-off voltage), under which the applications miss the required electric energy to work and therefore will shut-down. The cell is the energy/voltage source in the application; when the voltage drop at the cell during a pulse is lower than the cut-off voltage, the application will shut down. A proper design of the electrical application in terms of electrical load and cut-off voltage, combined with

the choice of the cell of right energy and power characteristics, are of paramount importance in order to achieve the targeted service-life of the application. The mutual relation that links application characteristics, cell performances and targeted application services is graphically illustrated below (Fig. 3). Consult Renata experts in order to select the cell with the right characteristics for your application and achieve your goal!

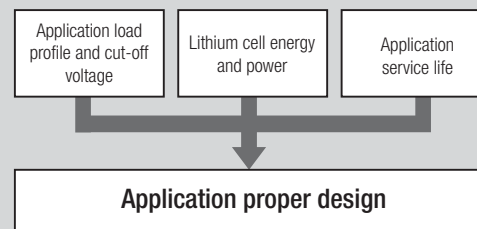

# Frequently Asked Questions (FAQ)

## Influence of temperature on electrical performance

### At which temperature can lithium coin cells be operated?

The operating temperatures of lithium coin cells are from -30°C to 70°C. Below -30°C the performances of the cells are significantly reduced, because of the increased internal resistance. The max. operating temperature for the lithium coin cells must not exceed 70°C, in order to avoid any electrolyte leakages, leading to reductions of cell functions.

Operating temperatures outside this range may be possible for limited times and under proper load regimes. Please ask Renata experts for advice on this matter.

### Has high temperature any detrimental effect on the cell performance?

Increasing temperature to values above room temperature will increase the rate of self-discharge, reducing the available cell capacity – thus shortening both the service-life and the shelf-life. The self-discharge of a cell is due to parasitic reactions taking place at the electrodes, consuming the electroactive material. As for every reaction, the rate of these processes is function of temperature. A simple "rule of thumb" to determine the self-discharge at a given temperature is the following: the rate of self-discharge increases of a factor 2 for every 10 degrees Celsius of temperature increase from room temperature (20°C). Given that at room temperature the rate of self-discharge of lithium coin cells is 1% of capacity loss per year, at 40°C (for example) the self-discharge rate will be:

$$1\% \times 2^{(40-20)/10} = 1\% \times 2^2 = 4\% \text{ of capacity loss/year.}$$

In addition to self-discharge considerations, the maximum storing and operating temperature for the lithium coin cells must not exceed 70°C, in order to avoid any electrolyte leakages, leading to reductions of cell functionality.

### Has low temperature any detrimental effect on the cell performance?

Generally speaking, the performances of a cell at low temperature are reduced because of the decreased conductivity of the electrolyte, which leads to an increase of internal resistance. As a

### Characteristics

Shelf life (temperature / time)

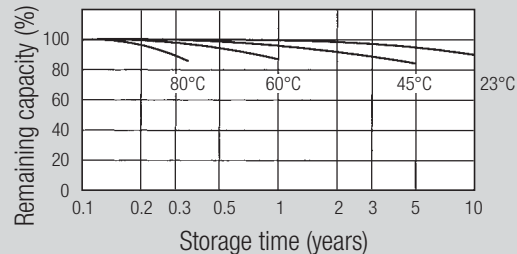

### Storage characteristics (CR2430)

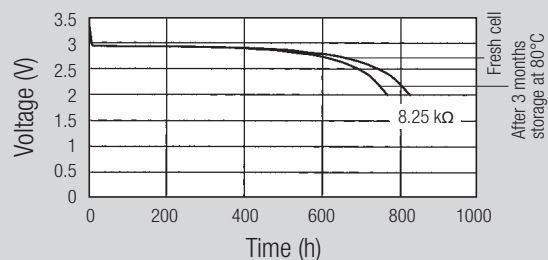
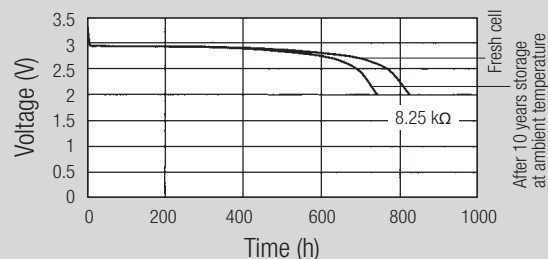
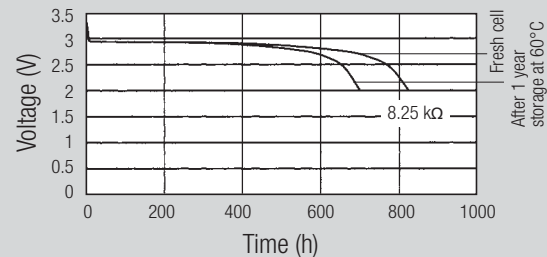

consequence, the ability of the cell to deliver high power is reduced. Especially when designing an application with high power demand (high current consumption, like pulse-loads), this factor must be carefully taken into account.



# Frequently Asked Questions (FAQ)

## Influence of storage / ageing on electrical performance



### **Which are the recommended storage conditions for lithium coin cells?**

The normal storage of lithium coin cells is made at temperature between +10°C and +25°C, never exceeding +30°C (also according to IEC 60086-1). In this way the maximum shelf-life (i.e. max. retention of cell performances after storage periods) of lithium coin cells is achieved. Storage temperatures above room temperature will increase the rate of self-discharge, reducing

the available capacity of the cell. Humidity above 95% R.H. and below 40% R.H. should also be avoided for sustained periods, as these extremes are detrimental to batteries.

Storing the cells at low temperature is also suggested, but attention must be paid when transferring the cells to warmer environments, because of the possibility of having water condensing on to the cells (risk of short-circuits).

## Influence of contact material

### **Which contact materials are recommended?**

Recommended contact materials:

- Gold plating – provides the most reliable metal to metal contact under all environmental conditions.
- Solid nickel – provides excellent resistance to environmental corrosion.
- Nickel clad stainless steel – performs almost as well as solid nickel.
- Nickel plated stainless steel – also a reliable metal to metal contact (also used for RENATA's battery holders SMTU/HU series).
- Inconel alloy – provides good electrical conductivity and corrosion resistance.

Never use tin plated contacts since in high humidity and polluted environments sulfides can form on the material and creep through pores in the coating.

### **Which contact force and design ensure best electrical performance and reliability?**

The contact force of the contacts should be between 2 and 10N (ca. 200 to 1000 gf).

Contact design: It is important that contacts apply sufficient pressure to hold the battery firmly in place and prevent electrical disconnections (even under shock conditions). Contacts must be able to resist permanent set. Furthermore, two contact points guarantee more reliability than only one.

## General FAQs

### **Can batteries undergo washing processes?**

Please use non-conductive cleaning solutions for the PCB washing process. In conductive solutions, the batteries are short-circuited, causing discharge, voltage drop and possibly deterioration of the cell performance. Use cleaning solutions that do not attack the polypropylene cell gasket.

### **Are Renata lithium cells certified in terms of safety?**

The safety of Renata cells is certified by Underwriters Laboratories Inc., Northbrook/IL/USA, under the file number MH14002. See also: [www.renata.com/content/3vlithium/tech\\_safety.php](http://www.renata.com/content/3vlithium/tech_safety.php) and the Safety Section in this Guide.

# Passivation Phenomena

Lithium is among the most reactive elements. It easily reacts with a number of substances, including water and air. Because of this high reactivity, the commercial exploitation of lithium-based electrochemical systems has been for long time hindered by the reaction between lithium and several electrolytes. Only in the 80s suitable electrolytes were developed, based on aprotic organic solvents which are stable when in contact with lithium metal.

The reason for the stability of electrolytes based on organic solvents lies in the passivation layer that is built at the lithium surface.

**This protective layer (also called SEI, Solid-Electrolyte-Interphase) stops the reaction between electrolyte and lithium and due to its mechanical characteristics also ensures good stability for long times. Therefore the formation of a layer of right properties is a key element for the achievement of long-term storage properties.**

The formation of the SEI layer is influenced by a number of factors, including the formulation of the electrolyte and the production conditions. In addition, a particular step of the mfg process plays a decisive role in the formation of the right SEI layer: the pre-discharge step (i.e. a discharge

limited to some % of the theoretical capacity of the cell) of 100% of the produced cells. By carefully controlling the pre-discharge parameters, a passivation layer of optimized physical-chemical characteristics is created at the interphase lithium-electrolyte.

Unlike other lithium-based battery technologies, the CR (Li/MnO<sub>2</sub>) system is not characterised by a passivation layer of growing thickness after long-term ageing of the cells or after short exposures at high temperature. The SEI layer of CR cells built at the beginning does not change significantly even after years of storage at controlled temperature (see related section in this chapter – FAQ about recommended storage conditions). In other lithium systems, instead, a growth of the layer with ageing time, is observed, turning out in a reduced pulse capability (the well-known "voltage delay effect, especially observed for liquid cathode systems when trying to request high pulses after long time storage at room temperature, or after short periods at high temperature). For these other lithium systems it is necessary to apply a continuous load of low current to minimize passivation phenomena; on the contrary, for CR systems this precaution is not necessary.

# Soldering

## Hand soldering

Never solder directly to the cell surface. Use cells with tabs only (see related section of our Products Line). Do not allow the soldering iron to get directly in contact with the battery body. Do not apply heat any longer than necessary to achieve a safe solder connection (max. 350°C for 5s in the soldering area of the tab).

## Wave soldering

During passage of the battery terminals through the solder wave, the battery is short-circuited. As this usually takes less than 5 seconds, the loss of capacity is negligible. Subsequent to a short-

circuit the battery voltage will recover to a value above 2.5 V almost immediately. Full recovery to the initial voltage may take hours or even days. Please note this effect in case electrical characteristics are measured while the battery voltage is recovering. The battery may appear to be defective, but it is not.

Never use **reflow** soldering! Lithium batteries are not suitable for reflow soldering processes. The high temperatures required for this soldering method would deform the gasket, causing electrolyte leakage, deterioration of the battery performance and possible rupture or ignition.

# Technical Consultancy Service

Application design support



**The world of electronic application does not cease to grow with impressive pace – every day new ideas and smart solutions are translated in powerful applications with innovative features.**

When selecting a battery, the following technical factors have to be considered:

- current consumption of the device
- pulse drain characteristics
- voltage – minimum and maximum values
- expected life time of the battery
- environmental temperatures
- mechanical and normative requirements / specification

Do not hesitate to get technical support directly from RENATA's engineering team to find the right battery for your particular application.

## **Contact data of Renata's Technical Customer Support**

For any technical question about Renata Lithium coin cells, holders, standard tab configurations or customized solution, please address your inquiries to our engineering team:

**Renata SA  
Technical Customer Support  
4452 Itingen  
Switzerland**

**Phone: +41 61 975 75 75  
Fax: +41 61 975 75 99  
Email: [support@renata.com](mailto:support@renata.com)**

---

## **Application Worksheet**

Renata Application Worksheet is our key tool for offering the best technical consultancy service to the developers of new electronic devices. By gathering all useful information about load and temperature conditions of use we deliver an ultimate feasibility evaluation and help selecting the right power source for a given application.

You can download a copy of the Application Worksheet from Renata's website or just fill and send via fax the copy reported below.

Please consider: Supplying the most detailed information will give the best accuracy to the battery assessment.

# Application Worksheet

Please submit the information according to the following selection guide and send the application worksheet back to your contact person.

## Customer Information

Company: _____	
Address: _____	
_____	
_____	
Contact Person: _____	Telephone: _____
Fax: _____	E-Mail: _____

## Electrical Characteristics

Voltage: V max  V      Cut-off V min  V  
Continuous load: I max  mA      I min  mA      I average  mA  
Capacity C  mAh

In case of pulse-loads, please define pulse parameters. Submitting your own detailed pulse scheme and using your own pulse description is strongly encouraged for best clarity. Alternatively you can use the following table of pulse parameters (defined according the scheme below):

## Pulse parameters

Basis-current ("stand-by" current) I1  mA      Time-on (pulse duration) t1  ms  
"Transmission" current I2  mA      Pulse period t2  s  
Peak current I3  mA      Time between two transmissions t3  h

## Pulse scheme

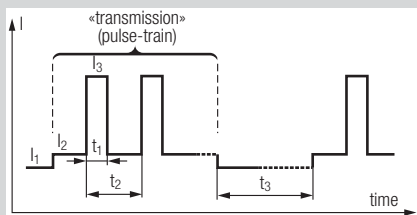

t<sub>1</sub>: pulse duration  
t<sub>2</sub>: pulse period  
t<sub>3</sub>: time between two transmissions

You can add further explanation / info about your pulse profile here

# Application Worksheet

## Temperature / Humidity

Please submit the temperature profiles to which your application will be typically exposed.

Temperature profile:  °C max.  °C min.  °C mean

Humidity:  % RH max.  % RH min.

For a precise performance evaluation, please indicate exactly how long the application will be exposed to each of the following temperatures:

Temperature	<0°C	0°-20°C	20°C	25°C	30°C	35°C	40°C	45°C
days per year	<input type="text"/>	<input type="text"/>	<input type="text"/>	<input type="text"/>	<input type="text"/>	<input type="text"/>	<input type="text"/>	<input type="text"/>

Temperature	50°C	55°C	60°C	65°C	70°C	75°C	80°C	85°C
days per year	<input type="text"/>	<input type="text"/>	<input type="text"/>	<input type="text"/>	<input type="text"/>	<input type="text"/>	<input type="text"/>	<input type="text"/>

## Dimensions / Weight / Mounting Mode

Dimensions: Max. diameter  mm Max. height  mm

Weight: Max. weight  g

Mounting Mode:  Plain cell; With soldering tags  horizontal or  vertical  
 In combination with a battery holder  
 Mounted on SMT board  Mounted on through-hole board.

Provide a detailed sketch for specific board layouts

## Operation Requirements

Expected operating life:  years Storage period:  years

## Specific Project Information

New project:  yes  no

Project name:  End customer:

Qty. pre-series:  pcs. Qty. 1st series  pcs.

Qty. P.A.:  pcs. / year

Target price:  per 100 pcs.  USD  EUR

## Product description

## Remarks

# Safety Guidelines

## Handling instructions



### Preventing Quality Problems

To prevent the batteries of being discharged please observe the following rules.

1. Do not place batteries on a conductive surface (anti-static work mat, packaging bag or form trays) as it can cause the battery to short.
2. Remove the batteries from the transport tray one at a time (do not throw batteries randomly by turning over trays)
3. Please make sure that batteries can't touch each other while handling them.

### Safety Guidelines and Precautions

Please observe the following warnings strictly. If misused, the batteries may explode or leak, causing injury or damage to the equipment.

1. Keep batteries out of the reach of children, especially those batteries fitting within the limits of the truncated cylinder defined in ISO/DP 8124/2.2 page 17. In case of ingestion of a cell or battery, the person involved should seek medical assistance promptly.
  2. Equipment intended for use by children should have battery compartments which are tamper-proof.
  3. The circuits of equipment designed to use alternative power should be such as to eliminate the possibility of the battery being overcharged
4. The batteries must be inserted into the equipment with the correct polarity (+ and -).
  5. Do not attempt to revive used batteries by heating, charging or other means.
  6. Do not dispose of batteries in fire. Do not dismantle batteries.
  7. Replace all batteries of a set at the same time. Newly purchased batteries should not be mixed with partially exhausted ones. Batteries of different electrochemical systems, grades or brands should not be mixed. Failure to observe these precautions may result in some batteries in a set being driven beyond their normal exhaustion point and thus increase the possibility of leakage.
  8. Do not short-circuit batteries.
  9. Avoid directly soldering to batteries.
  10. Do not expose batteries to high temperatures, moisture or direct sunlight.
  11. When discarding batteries with solder tags, insulate the tags by wrapping them with insulating tape.
  12. Improper welding can damage the internal components of batteries and impair their performance.

### Correct replacement of a coin cell

Renata's horizontal SMT and through-hole battery holders are made of heat resistant, glass fibre filled Liquid Crystal Polymer (LCP).

Despite the excellent characteristics of this holder material, it can happen that a holder is damaged

when trying to replace a coin cell in an inappropriate manner.

In order to minimize such risk of damage, please replace the coin cell as demonstrated in the pictures below:

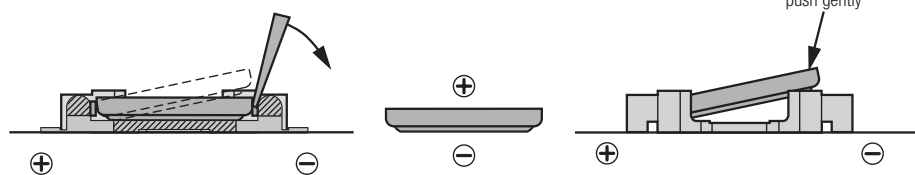

# Safety Guidelines

## Underwriters Laboratories' (UL) Safety Approval



### Introduction

#### Safety Approval of RENATA LITHIUM Products



#### Underwriters Laboratories Inc. Northbrook / IL / USA

Recognition covers under the file number MH14002 the following Renata Lithium products:

#### Button cells

CR1025, CR1216, CR1220, CR1225, CR1616, CR1620, CR1632, CR2016, CR2025, CR2032, CR2320, CR2325, CR2430, CR2450N, CR2477N.

These cells may have an additional two letter suffix which denotes type of solder tab or wire lead, or the mode of packaging or an additional letter and three digits suffix which denotes type of solder tab or wire lead.

#### Power modules

With Decoupling Diodes	Without Decoupling Diodes
1000-1	175-0; 1000-0
1000-1B	175-0B; 1000-0B
175-2	338A

### Conditions of Acceptability

The use of these cells may be considered generally acceptable under the conditions given below:

1. The cells are identified in accordance with "Marking" as described below.
2. Unless the conditions of Par. 2A are met, these batteries are to be used only in devices where servicing of the battery circuit and replacement of the lithium battery will be done by a trained technician.

2A. All of these batteries are acceptable for use in user-replaceable applications when used in accordance with the following except for Model CR2477N:

2A.1 The end product must be designed to prevent reverse polarity installation of the battery, or if the battery is reversed, the short- or open circuiting of any protective component, one component at a time, shall not result in forced-discharge of the battery.

2A.2 The end product shall contain a warning notice adjacent to the battery stating the following: "Replace Battery With (Battery Manufacturer's Name or End-Product Manufacturer's Name), Part No. ( ) Only. Use of another battery may present a risk of fire or explosion. See owner's manual for safety instructions".

2A.3 The instruction manual supplied with the end product shall also contain the above warning notice along with instructions to the user as to where replacement batteries can be obtained. The instruction manual shall also contain the following additional warning notice: **"WARNING, Battery may explode if mistreated. Do not recharge, disassemble or dispose of in fire."**

3. These cells are intended for use at ordinary temperatures where anticipated high temperature excursions are not expected to exceed 100°C (212°F).

4. These cells can be used in series up to a maximum of four cells of the same model number. When used in series, there should be instructions adjacent to the cells stating that when the cells are replaced, they should all be replaced at the same time using fresh cells only. These cells should not be connected in series with any other (other than the allowed number of cells in series) power source that would increase the forward current through the cells.

5. The circuit for these cells shall include one of the following:

A) Two suitable diodes or the equivalent in series with the cells to prevent any reverse (charging) current. The second diode is used to provide protection in the event that one should fail. Quality control, or equivalent procedures, shall be



# Safety Guidelines

## Underwriters Laboratories' (UL) Safety Approval



established by the device manufacturer to insure the diode polarity is correct for each unit, or

B) A blocking diode or the equivalent to prevent reverse (charging) current, and in the event of

diode failure, the cells shall be further protected against reverse (charging) current in excess of the values shown below. The measurement of this current shall include appropriate abnormal tests.

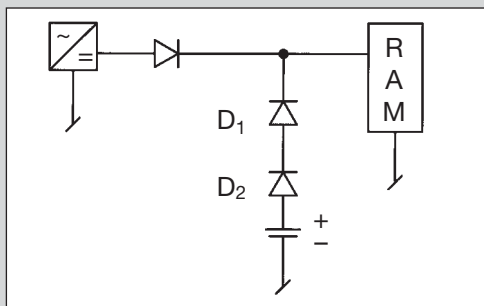

When D<sub>1</sub> is shorted D<sub>2</sub> still protects battery against recharging.

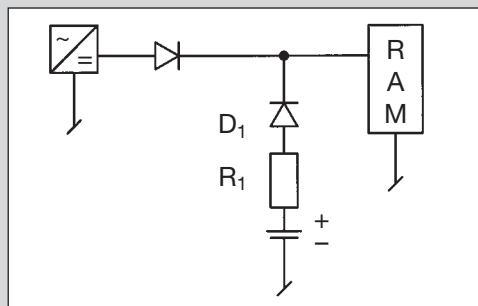

R<sub>1</sub> limits the recharging current when D<sub>1</sub> fails.

**Note:** An additional voltage drop over D<sub>2</sub> or R<sub>2</sub> must be considered when battery is operating.

Model No.	Max. Abnormal Charging Current (mA)	User replaceable
CR1025	5.0	Yes
CR1216	5.0	Yes
CR1220	25	Yes
CR1225	25	Yes
CR1616	25	Yes
CR1620	25	Yes
CR1632	25	Yes
CR2016	25	Yes
CR2025	25	Yes

Model No.	Max. Abnormal Charging Current (mA)	User replaceable
CR2032	25	Yes
CR2320	25	Yes
CR2325	25	Yes
CR2430	25	Yes
CR2450N	25	Yes
CR2477N	25	No
175-(a)	25	Yes
338A	25	Yes
1000-(a)	25	Yes

# Safety Guidelines

## UL safety tests

### Abnormal Charging Test

The cells were charged by being connected in opposition with a 12 V dc power supply. The current was controlled by connecting a resistor of the appropriate size in series with the cell. The test duration was based on the applied current and the capacity of the cells.

The cells were examined after these tests for any sign of change.

Five samples each of Models 1000-0, 1000-7 and CR2450N in the as-received condition were used in these tests.

**Results** None of the cells leaked. There were no fires or explosions as a result of tests at currents below 100 mA for the abnormal charging mode.

### Crush Tests

The cells were crushed between a flat surface and a cylindrical surface having a radius of curvature of 5/16 in. The force was applied by means of a hydraulic ram and the cells were crushed until the thickness at the point of maximum crushing was less than one-fourth of the original cell thickness. The temperatures on the exterior surface of the metal cell casing was monitored by means of an iron-constantan thermo-couple. The cells were examined after the

test for any signs of reaction due to the crushing. Five fresh Model CR916 cells were used in this test.

**Results** The casings opened and leaked as a result of this test. There was no temperature increase or any other adverse reaction as a result of this test.

### Explosion Test

A cast aluminum chamber, 6 in. in diameter and 12 in. high with a 3/4 in. vent opening, was used for the test. Iron flanges were attached to both ends of the chamber. A solid 0.020 in. steel plate and a second thicker reinforcing steel plate with a 4 in. diameter hole in the center were bolted together to the bottom flange. Each sample cell tested was placed in turn in the chamber and centered on the bottom plate. Steel plates weighing 30 lb. were placed on top of the chamber. A

1-1/2 in. diameter Meker burner was ignited and placed under the chamber. The chamber was heated until the test cell exploded. Five Model 1000-0, 1000-7 and CR2450N cells were used in these tests.

**Results** Models 1000-0 and 1000-7 exploded, however did not lift the lid. Model CR2450N did not explode, however a fire did occur inside the explosion chamber.

### Fire Exposure Tests

One sample was placed on a wire screen directly above a 2 in. diameter laboratory Meker burner fuelled by methane gas at a pressure of 0.5 psig and a flow rate of 3.0 ft<sup>3</sup>/h. The cells were heated until they exploded or until ultimate results were obtained. For protection and also to muffle the sound of any explosions, the cells were tested in a room separate from the observer. The results of

this test were used to determine if further testing would be needed to evaluate the fire exposure hazard of these cells. Five fresh cells were used in this test.

**Results** Models 1000-0, 1000-7 and CR2450N exploded. Based on these results, the Explosion Test was deemed necessary.

# Safety Guidelines

## UL safety tests

### Heating Tests

The power modules were heated in an oven. The temperature on the exterior surface of the module casing was measured by means of an iron-constantan thermocouple. The heating rate was controlled with a variable transformer and ranged

from 1°C/min. to 11°C / min. The heating was discontinued at 180°C (356°F). The modules were examined after the test for any signs of change.

The following modules were used in these tests:

Previous conditioning of modules	No. of 1000-2 cells	No. of 500-1 cells
Fresh modules	3	2
After oven exposure	2	3
After temperature cycling	3	2
Cells discharged at room temperature:		
Completely discharged	2	3
One-half discharged	3	2
Cells discharged at 71°C (160°F)		
Completely discharged	2	3
One-half discharged	3	2

**Results** There were no fires or explosions at temperatures below 165°C (329°F). There were no indications of increased reactivity as a result of exposure in the conditioning tests.

### Puncture and Leaking Test

Cells were punctured by cutting through the cell casing with a small grinding wheel until liquid or gas was released from the cell.

**Results** The cells were found to contain only a few drops of an organic liquid. The cells were not pressurized and no gas, liquid or solid particles were sprayed from the cells.

### Short Circuit Test

The cells were shorted by connecting the positive and negative terminals with a short length of copper wire. The temperature on the exterior surface of the metal cell casing was monitored during the test by means of an iron-constantan thermocouple.

Short circuit tests were conducted on cells at room temperature. After the tests, the cells were examined for any signs of change.

The following cells were used in these tests:

Model CR2450N	
Previous conditioning of cells	Number of cells at room temperature
Fresh cells	5

**Results** There were no signs of case bulging, leaking, or any other visible changes as a result of these tests. The maximum temperature measured on the exterior surface of the metal cell casings was 30°C (86°F) for the tests conducted at room temperature. The maximum temperatures were obtained in tests with fresh cells.

# Safety Guidelines

## UL safety tests

### Temperature Cycling

Eighteen button cells of each CR2032 and CR2430 were left in following conditions. The cells were exposed to alternate temperatures of +20° and +100°C. The batteries were submitted to these temperatures in 60 cycles of two hours each and then discharged over a load of 8,25 k Ohms down to 2 volts in order to detect remaining capacity.

**Results** The cells showed no visible change as a result of the temperature cycling and relevant discharge results are shown in the diagrams of this page.

Ten each of the Modules 1000-2 and 500-1 were conditioned in this exposure. The modules were exposed to alternate temperatures of -54°C (-65°F) and 71°C (160°F) for a total of ten exposures at each temperatures. The modules were exposed at each temperature for periods of 16 h with 8 h periods at room temperature between each exposure. The temperatures of the oven and the cold box were monitored by means

of iron-constantan thermo-couples connected to a recording potentiometer.

**Results** None of the modules had a weight loss greater than 0.01 g and the maximum change in open circuit voltages was 0.1 V. There were no visible changes as a result of this exposure.

"Further tests have been executed, mainly with Models 500-1 and 1000-2: Discharge, Drop Test, Vibration Test, Oven Exposure and Humidity Test."

# Safety Guidelines

## Disposal of used batteries

### General Guidelines

The disposal of used batteries is governed by law in many countries world-wide. Therefore, please check your local regulations prior to battery disposal.

### Safety Precautions for disposal of used batteries.

### Safety precautions for the handling and storage of used lithium batteries.

Although environmentally friendly and free of harmful substances, lithium batteries are a powerful energy source and require some caution even if almost fully discharged. When disposing of large quantities of lithium coin cells it is necessary to take certain safety measures in order to avoid heat generation and the danger of fire due to mass short-circuiting:

- 1.** The number of lithium coin cells to being disposed of and placed in the same container during a day should be limited (if possible less than 100 pieces per day).
- 2.** The container for disposal should be made of metal (small steel drums are quite suitable), not

exceed a volume of 10 liters, be closed with a cover and have air holes in the upper area of the side walls.

**3.** For the storage of these containers, the following safety rules should be observed:

- Containers to be stored outdoors, protected from rain, at least 2 - 3 meters away from buildings.
- Distance between containers at least 1 meter.
- Storage area not accessible to unauthorized persons.

**4.** It is recommended to mix the batteries in the containers daily for one week in order to ensure complete discharge and prevent the battery waste from heating up at a later stage.

As indicated above, these safety measures are only necessary if relatively large quantities of lithium batteries must be disposed of at the same time. In the retail/consumer trade, where only single batteries are changed and used batteries of different kinds are mixed together, there is no risk of battery waste heating up dangerously.

# Quality Management System

Since the very beginning of its business activities, when Renata first started as a supplier of batteries to the Swiss watch industry, it developed a high level of quality-consciousness. **"Quality comes first"** rules at every level of the enterprise.

Renata's quality management system is certified according to the **ISO 9001:2000** standard. RENATA is implementing **TS 16949** processes and prepares for certification.

The basis for providing our worldwide customers with top quality products is our continuous product and process improvement.

**The open circuit voltage (OCV), closed circuit voltage (CCV) and mechanical dimensions of every single RENATA lithium battery are checked individually.**

Batteries only leave our factory after a mandatory **storage period (quarantine) of at least 3 weeks**. During this period of time extensive performance testing is done.

This testing comprises:

- various leakage resistance tests
- shelf life tests
- storage under varying atmospheric conditions (artificial aging)

- discharge tests to monitor capacities
- electrical characteristic testing (voltage, internal resistance, etc.)
- visual checks, including internal components of dismantled batteries

The flow chart on next page shows the main production steps and the integrated quality control procedures for RENATA lithium batteries.

The controls on the product are the following (see process flow chart on the next page):

**1** Statistical control ("Quality tests" step)

performed for every batch, consisting of

- a) discharge capacity check
- b) leakage tests

**2** After the Quality tests are successfully completed, 100% of each batch is controlled in terms of OCV, internal resistance (resistive load method) and height ("Final control 100%" step).

**3** If the battery is tabbed, after the tab welding 100% of each batch is re-controlled in terms of OCV, internal resistance (resistive load method; "Battery tagging 100% electrical and tags" step).

# Process Flow Chart

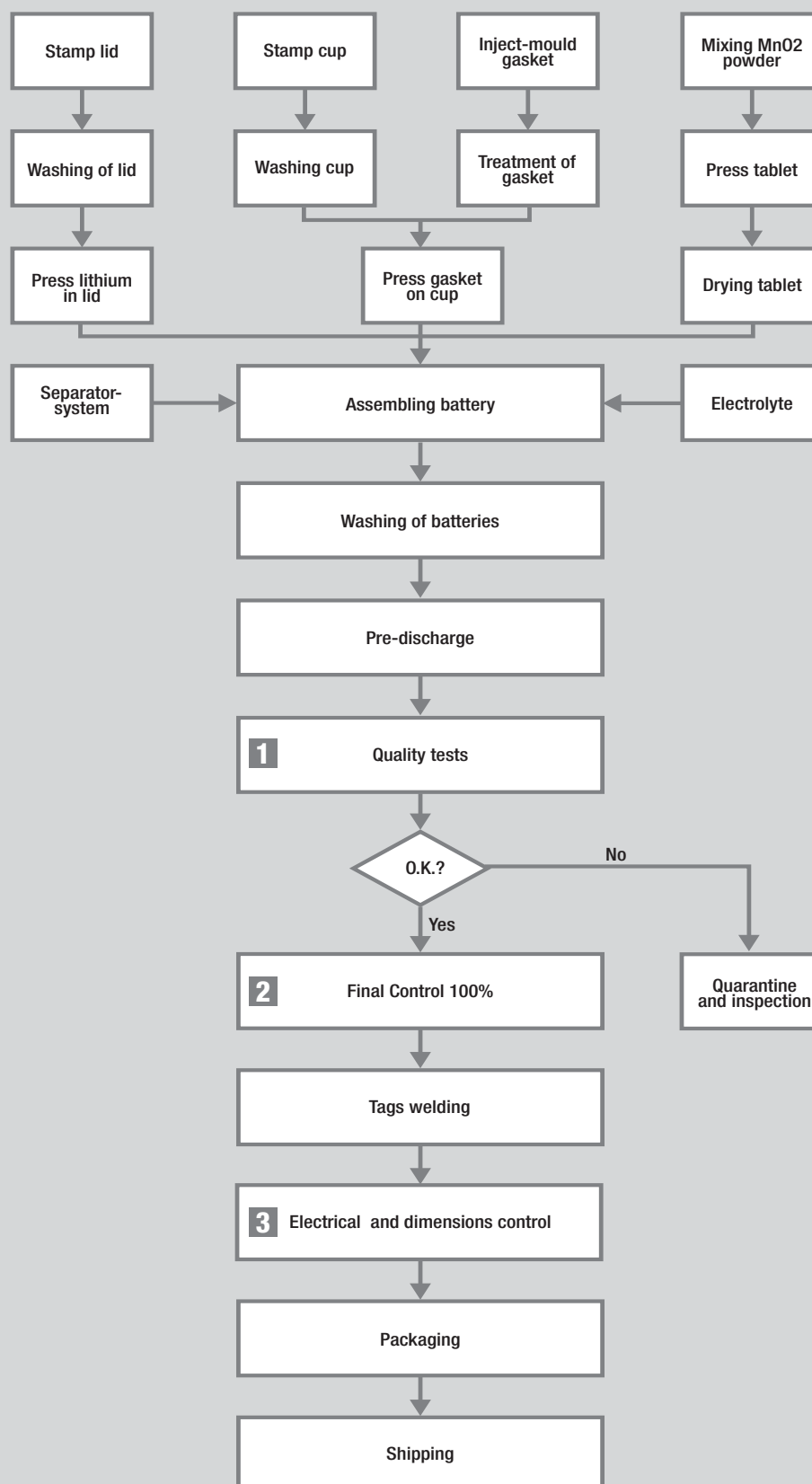

# Certificates and Declarations

Certificate: ISO 9001:2000

renata  
batteries

MANAGEMENT SYSTEM

## CERTIFICATE

INTERNATIONAL CERT Zertifizierung GmbH certifies that

renata  
batteries  
A COMPANY OF THE SWATCH GROUP

### Renata SA

located at:

CH 4452 Itingen

for the scope:

**Development, manufacture and distribution of micro batteries for electronic applications**

applies a quality system which meets the requirements of

**ISO 9001**

version 12/00

this certificate is valid until:  
Certificate-Register-No.:  
Geiselhöring

June 12, 2008  
CH 607000  
July 24, 2006



Senior Executive of the Certification Body  
INTERNATIONAL CERT Zertifizierung GmbH  
Straubinger Straße 2, D 94333 Geiselhöring, Phone: +49 9423 9412-0



**TGA-ZM-013-96-00**

duplicate



# Certificates and Declarations

## Certificate: UL Safety Approval



You can see and download the certificate for UL Safety approval at the UL Online Certifications Directory website: <http://database.ul.com/cgi-bin/XYV/template/LISEXT/1FRAME/index.htm>

bei searching under company name RENATA.

Renata's coin cells and Power Modules are certified under the file no. MH14002.

## Declaration: Conformity with RoHS

### What is RoHS?

European Union (EU) environmental legislation about the RESTRICTION of the Use of certain HAZARDOUS SUBSTANCES (RoHS) in electrical and electronic equipment

### What does RoHS imply?

Member States shall ensure that, from 1 July 2006, new electrical and electronic equipment put on the market does not contain:

- Lead (Pb),
- Mercury (Hg),
- Hexavalent Chromium (Cr),
- Cadmium (Cd),
- Polybrominated biphenyls (PBBs) and
- Polybrominated diphenyl ethers (PBDEs)

### RoHS: Affected products of the RENATA portfolio

#### Coin cell holders



#### Tabbed coin cells



The pre-tinning of the solder contacts used to contain some lead

**Now they are leadfree**

#### Batteries

(incl. coin cells)



Batteries do not fall under the RoHS 2002/95/EC regulations

Batteries are governed by the

**Battery Directive 1991/157/EEC**

**RENATA batteries comply with this directive**

For the declaration of conformity to RoHS please refer to the CERTIFICATE OF COMPLIANCE with Battery Directive 1991/157/EC (see next page).

# Certificates and Declarations

Declaration: Conformity with Battery Directive 1991/157/EC

renata  
batteries

the swiss power source

renata  
batteries

## CERTIFICATE OF COMPLIANCE with EU Battery Directive 1991/157/EEC

Renata SA's range of 3V Lithium Manganese Dioxide coin cells:

Renata CR1025	Renata CR2016 MFR	Renata CR2320
Renata CR1216	Renata CR2016	Renata CR2325
Renata CR1220	Renata CR2025 MFR	Renata CR2430
Renata CR1225	Renata CR2025	Renata CR2450N
Renata CR1616	Renata CR2032 MFR	Renata CR2450HT
Renata CR1620	Renata CR2032	Renata CR2477N
Renata CR1632		

This document certifies that the battery models as stated above and provided by Renata SA are in compliance with

**EU Battery Directive No. 1991/157/EEC of 18.3.1991  
and its Technical Adaptation No. 1998/101/EC of 22.12.1998**

9<sup>th</sup> October 2006

Renata SA

  
Marcel Bieri  
CEO

  
Eric Weber  
CTO

### Applicability of RoHS and WEEE Directives on Batteries:

- The RoHS Directive

*Directive 2002/95/EC of the European Parliament and of the Council of 27.01.2003 on the restriction of the use of certain hazardous substances in electrical and electronics equipment (RoHS Directive).*

does not apply on batteries. (see preamble 9 of this directive)

- The WEEE Directive

*Directive 2002/96/EC of the European Parliament and of the Council of 27.01.2003 on waste electrical and electronic equipment (WEEE Directive).*

does apply on batteries and requires their removal and separate collection. Once removed from WEEE, spent batteries are governed by the Battery Directive 1991/157/EEC.

Renata SA  
CH-4452 Itingen/Switzerland

Tel. +41 (0)61 975 75 75  
Fax. +41 (0)61 975 75 95

[sales@renata.com](mailto:sales@renata.com)  
[www.renata.com](http://www.renata.com)

A COMPANY OF THE SWATCH GROUP

# Certificates and Declarations

Declaration: Mercury-free products



the swiss power source



## CERTIFICATE OF COMPLIANCE with 0% Mercury content

Renata SA's range of 3V Lithium Manganese Dioxide coin cells:

Renata CR1025	Renata CR2016 MFR	Renata CR2320
Renata CR1216	Renata CR2016	Renata CR2325
Renata CR1220	Renata CR2025 MFR	Renata CR2430
Renata CR1225	Renata CR2025	Renata CR2450N
Renata CR1616	Renata CR2032 MFR	Renata CR2450HT
Renata CR1620	Renata CR2032	Renata CR2477N
Renata CR1632		

This document certifies that the battery models as stated above and provided by Renata SA contain

**0% Mercury**

9<sup>th</sup> October 2006

Renata SA

  
Marcel Bieri  
CEO

  
Eric Weber  
CTO

Renata SA  
CH-4452 Illingen/Switzerland

Tel. +41 (0)61 975 75 75  
Fax. +41 (0)61 975 75 95

[sales@renata.com](mailto:sales@renata.com)  
[www.renata.com](http://www.renata.com)

A COMPANY OF THE  SWATCH GROUP

# Certificates and Declarations

## Declaration: Conformity with IATA, ICAO and DOT regulations



### **Transportation of Lithium Batteries**

The transportation of lithium batteries is regulated by the International Air Transport Association (IATA), the International Civil Aviation Organization (ICAO) and by the U.S. Department of Transportation (DOT).

#### **1. IATA and ICAO Special Provisions A45**

All RENATA lithium batteries are considered as non-hazardous since they meet the Special Provisions A45, as published in IATA's handbook, 41st edition, effective 1 January 2000.

These provisions require: "Batteries must be separated so as to prevent short circuits and must be packed in strong packaging, except when installed in electronic devices".

All RENATA Li/MnO<sub>2</sub> cells or batteries have solid cathodes and contain less than 1 gram of lithium or lithium alloy.

Also the batteries are approved in accordance to UN Special Provision SP 188-Manual of Tests & Criteria Part III Subsection 38.3.

#### **2. DOT**

All RENATA lithium batteries are not subject to the requirements of the DOT Subchapter C, Hazardous Material Regulations because all our batteries meet the requirements of 49 CFR173.185(b).

Material Safety Data Sheets (MSDS) of each reference are available on request.

# How to find us

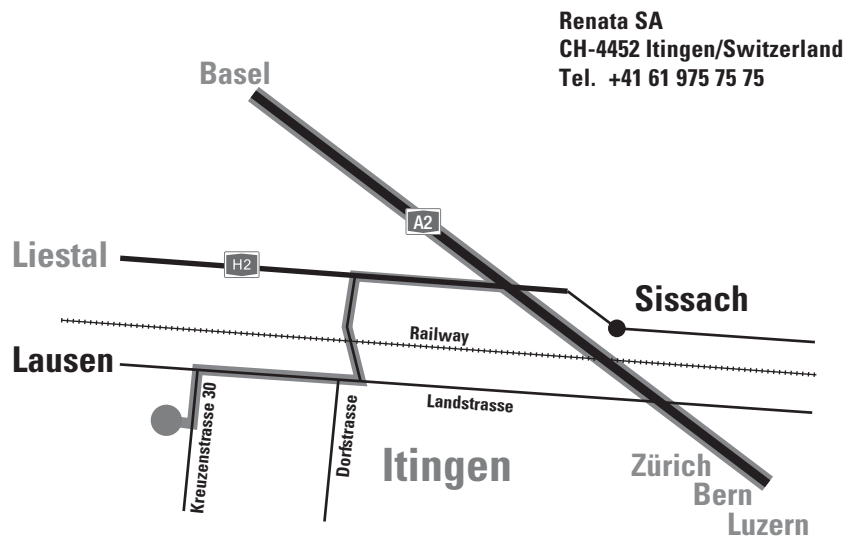

- Exit Itingen (A2)
- Direction Itingen
- Over the railway bridge
- Right – direction Lausen
- Left – Kreuzenstrasse 30, Renata SA, main entrance





# Li/MnO<sub>2</sub>

Distributed by:

**renata**  
batteries

Renata SA  
CH-4452 Itingen/Switzerland  
Tel. +41 61 975 75 75  
Fax +41 61 975 75 95  
sales@renata.com  
www.renata.com

